

LSC520WU

LSC521WU

Projector User Guide

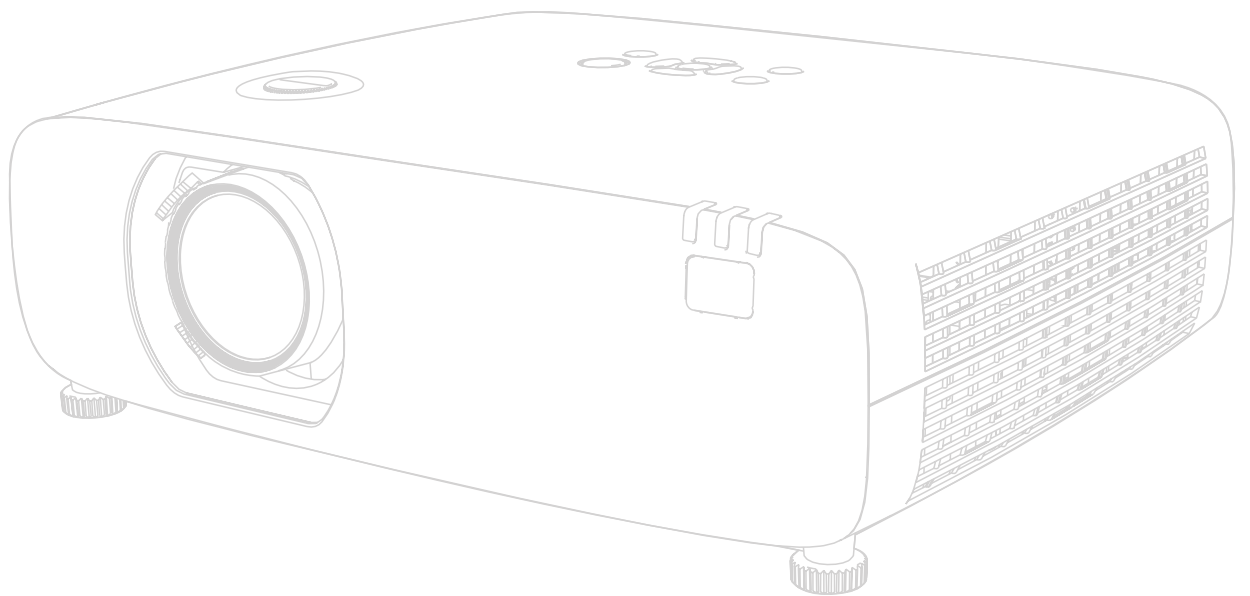

IMPORTANT: Please read this User Guide to obtain important information on installing and using your product in a safe manner, as well as registering your product for future service. Warranty information contained in this User Guide will describe your limited coverage from ViewSonic® Corporation, which is also found on our web site at <http://www.viewsonic.com> in English, or in specific languages using the Regional selection box on our website.

Model No. VS20173 | VS20174
P/N: LSC520WU | LSC521WU

Thank you for choosing ViewSonic®

As a world-leading provider of visual solutions, ViewSonic® is dedicated to exceeding the world's expectations for technological evolution, innovation, and simplicity. At ViewSonic®, we believe that our products have the potential to make a positive impact in the world, and we are confident that the ViewSonic® product you have chosen will serve you well.

Once again, thank you for choosing ViewSonic®!

Safety Precautions

Please read the following **Safety Precautions** before you start using the projector.

- Keep this user guide in a safe place for later reference.
- Read all warnings and follow all instructions.
- Allow at least 20" (50 cm) clearance around the projector to ensure proper ventilation.
- Place the projector in a well-ventilated area. Do not place anything on the projector that prevents heat dissipation.
- Do not place the projector on an uneven or unstable surface. The projector may fall over, causing personal injury or projector malfunction.
- Do not look straight at the projector lens during operation. The intense light beam may damage your eyes.
- Always open the lens shutter or remove the lens cap when the projector lamp is on.
- Do not block the projection lens with any objects when the projector is under operation as this could cause objects to become heated and deformed or even cause a fire.
- The lamp becomes extremely hot during operation. Allow the projector to cool for approximately 45 minutes prior to removing the lamp assembly for replacement.
- Do not use lamps beyond the rated lamp life. Excessive use of lamps beyond the rated life could cause them to break on rare occasions.
- Never replace the lamp assembly or any electronic component unless the projector is unplugged.
- Do not attempt to disassemble the projector. There are dangerous high voltages inside which may cause death if you should come into contact with live parts.
- When moving the projector, be careful not to drop or bump the projector on anything.
- Do not place any heavy objects on the projector or connection cables.
- Do not stand the projector on end vertically. Doing so may cause the projector to fall over, causing personal injury or projector malfunction.
- Avoid exposing the projector to direct sunlight or other sources of sustained heat. Do not install near any heat sources such as radiators, heat registers, stoves, or other devices (including amplifiers) that may increase the temperature of the projector to dangerous levels.
- Do not place liquids near or on the projector. Liquids spilled into the projector may cause it to fail. If the projector does become wet, disconnect it from the power supply and call your local service center to have the projector serviced.

- When the projector is under operation, you may sense some heated air and odor from its ventilation grill. It is a normal operation and not a defect.
- Do not attempt to circumvent the safety provisions of the polarized or grounding-type plug. A polarized plug has two blades with one wider than the other. A grounding-type plug has two blades and a third grounding prong. The wide and third blade are provided for your safety. If the plug does not fit into your outlet, obtain an adapter and do not attempt to force the plug into the outlet.
- When connecting to a power outlet, DO NOT remove the grounding prong. Please ensure grounding prongs are NEVER REMOVED.
- Protect the power cord from being treaded upon or pinched, particularly at the plug, and at the point where it emerges from the projector.
- In some countries, the voltage is NOT stable. This projector is designed to operate safely within a voltage between 100 to 240 volts AC, but could fail if power cuts or surges of ± 10 volts occur. In areas where voltage may fluctuate or cut out, it is recommended that you connect your projector through a power stabilizer, surge protector, or uninterruptable power supply (UPS).
- If smoke, an abnormal noise, or a strange odor is present, immediately switch the projector off and call your dealer or ViewSonic®. It is dangerous to continue using the projector.
- Use only attachments/accessories specified by the manufacturer.
- Disconnect the power cord from the AC outlet if the projector is not being used for a long period of time.
- Refer all servicing to qualified service personnel.

CAUTION: Possibly hazardous optical radiation is emitted from this product. As with any bright light source, do not stare into the beam.

CLASS 1 Consumer Laser Product EN50689:2021

- Notice is given to supervise children and to never allow them to stare into the projector beam at any distance from the projector.
- Notice is given to use caution when using the remote control for starting the projector while in front of the projection lens.
- Notice is given to the user to avoid the use of optical aids such as binoculars or telescopes inside the beam.



RG2 IEC 62471-5:2015.

Safety Precautions - Ceiling Mounting

Please read the following **Safety Precautions** before you start using the projector.

If you intend to mount the projector on the ceiling, it is strongly recommended that you use a proper fitting projector ceiling mount kit and that you ensure it is securely and safely installed.

If you use an inappropriate projector ceiling mount kit, there is a safety risk that the projector may fall from the ceiling due to an improper attachment through the use of the wrong gauge or length screws.

Contents

Safety Precautions.....	3
Introduction	8
Package Contents	8
Product Overview	10
Projector.....	10
Keypad.....	11
I/O Ports	12
Remote Control	13
Initial Setup.....	17
Choosing a Location - Projection Orientation.....	17
Projection Dimensions.....	18
Mounting the Projector	22
Using the Security Bar	22
Making Connections	23
Connecting to Power	23
Connecting to External Devices	24
VGA Connection	24
VGA Out Connection	25
Composite Video Connection.....	26
HDMI Connection	27
Audio Connection.....	28
USB Connection.....	29
Network Connection	31
RS-232 Connection	32
HDBaseT Connection.....	33
Using the Projector.....	34
Turning the Projector On.....	34
Selecting an Input Source	35
Adjusting the Projected Image	36
Adjusting the Projector’s Height and Projection Angle.....	36
Adjusting the Focus, Keystone, and Lens Shift.....	37
Turning the Projector Off	38

Menu Operation.....	39
On-Screen Display (OSD) Menu	39
Menu Navigation	40
On-Screen Display (OSD) Menu Tree.....	41
Menu Options.....	47
Display	47
Image Settings.....	49
Settings.....	51
Advanced.....	53
USB-A	58
Information	60
Appendix.....	61
Specifications.....	61
Projector Dimensions	62
Timing Chart	63
HDMI Signal.....	64
Troubleshooting	65
LED Indicators.....	67
Maintenance.....	68
General Precautions	68
Cleaning the Lens	68
Cleaning the Case	68
Storing the Projector	68
Cleaning the Filter	69
Regulatory and Service Information	70
Compliance Information.....	70
FCC Compliance Statement.....	70
Industry Canada Statement.....	70
CE Conformity for European Countries	71
Declaration of RoHS2 Compliance.....	72
Indian Restriction of Hazardous Substances	73
Product Disposal at End of Product Life	73
Copyright Information	74
Customer Service	75
Limited Warranty	76
Mexico Limited Warranty.....	79

Introduction

Package Contents

LSC520WU

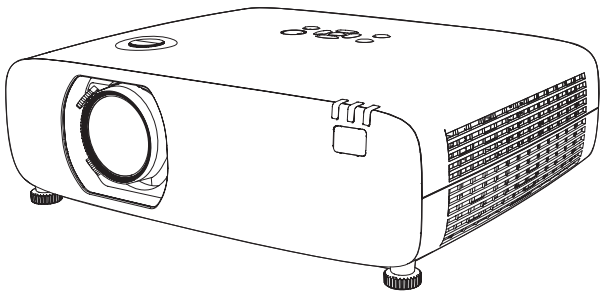

①



②



③



④

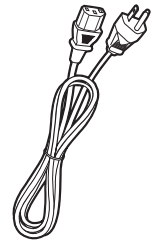

⑤

Number	Description
1	Projector
2	Remote Control
3	Batteries
4	Quick Start Guide
5	Power Cord

NOTE: The power cord and remote control included in your package may vary depending on your country. Please contact your local reseller for more information.

LSC521WU

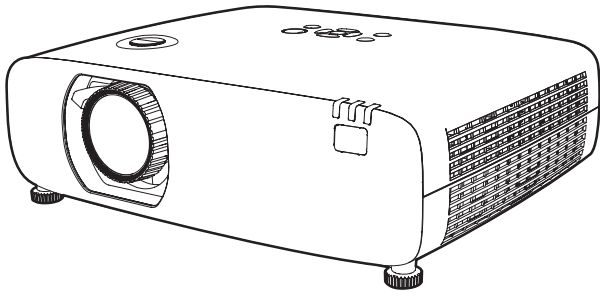

①



②



③



④

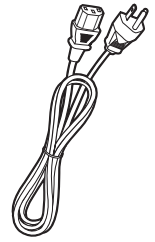

⑤

Number	Description
1	Projector
2	Remote Control
3	Batteries
4	Quick Start Guide
5	Power Cord

NOTE: The power cord and remote control included in your package may vary depending on your country. Please contact your local reseller for more information.

Product Overview

Projector

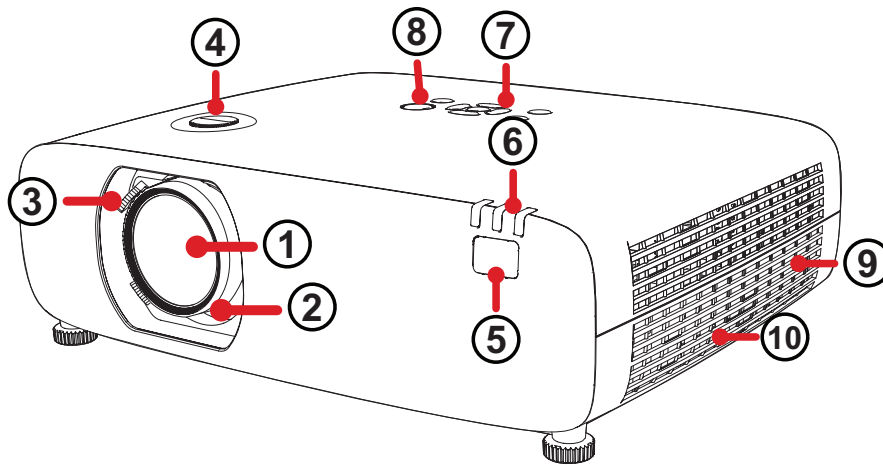



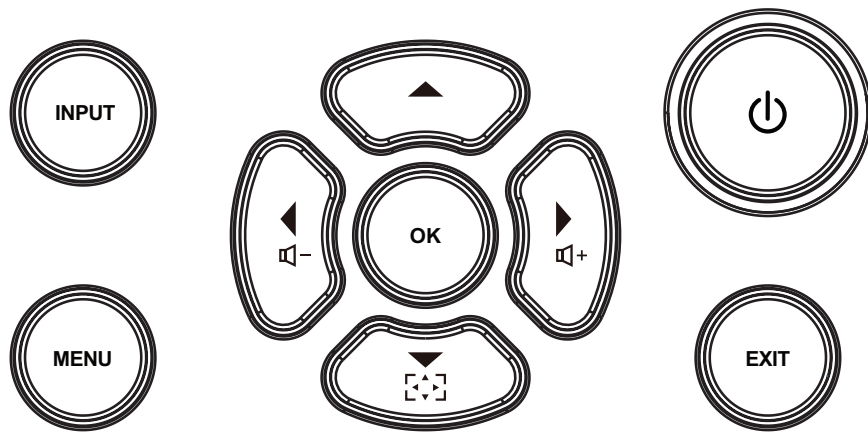

Number	Description
1	Projection Lens
2	Focus Ring
3	Zoom Ring
4	Lens Shift (V)
5	Remote Control IR Sensor
6	LED Indicator
7	Keypad
8	Power Button
9	Vent
10	Filter

NOTE: Do not block projector intake and exhaust vents.

Keypad



Key		Description
INPUT	Input	Displays the input source selection bar.
MENU	Menu	Open the On-Screen Display (OSD) Menu.
	Power	Toggles the projector between standby mode and Power On.
EXIT	Exit	Close the On-Screen Display (OSD) Menu.
	Navigation	Selects the desired menu items and makes adjustments when the On-Screen Display (OSD) Menu is activated.
	Volume	Adjust the sound level.
	Keystone	Opens the Keystone menu to correct distorted images resulting from an angled projection.

I/O Ports

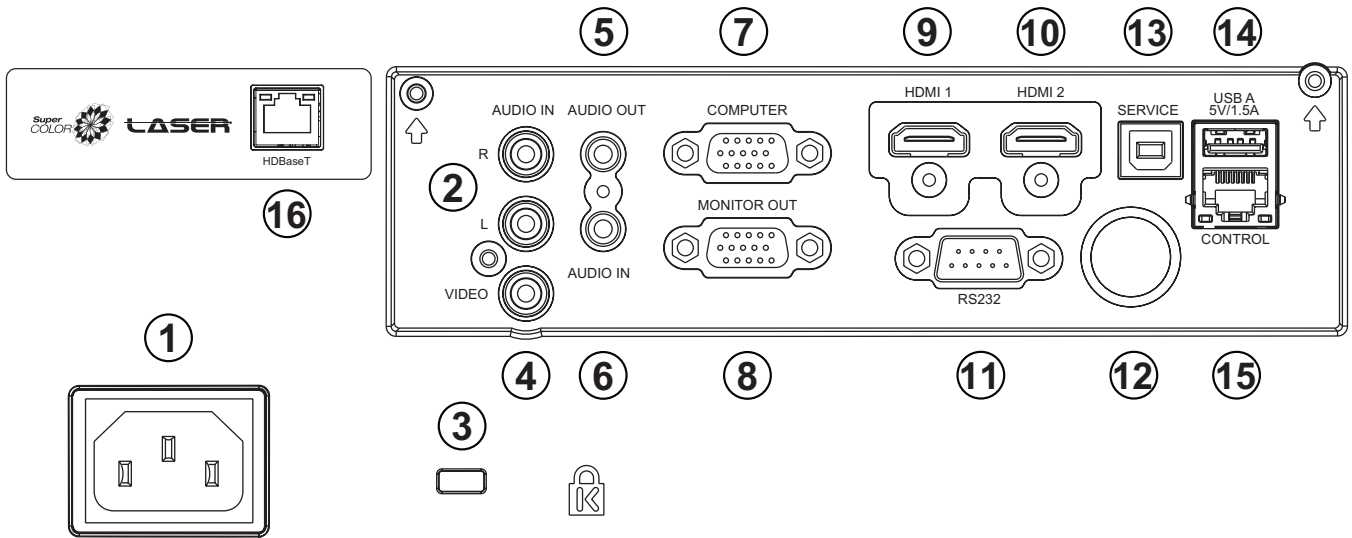



Port		Description
1	AC IN	AC IN socket.
2	AUDIO IN (L/R)	Connection for stereo audio signal.
3	Security Slot	Security slot for securing the projector to a fixed object.
4	VIDEO	Composite video port.
5	AUDIO OUT	Audio signal output port.
6	AUDIO IN	Audio signal input port.
7	COMPUTER	RGB (PC) signal input port.
8	MONITOR OUT	RGB (PC) signal output port.
9	HDMI 1	HDMI port.
10	HDMI 2	HDMI port.
11	RS-232	RS-232 control port.
12	Remote Control IR Sensor	IR Sensor.
13	SERVICE	USB Type B port for service and USB display.
14	USB A 5V/1.5A	USB Type A port for reader (USB 2.0, FAT32) and power.
15	CONTROL	LAN control port.
16	HDBaseT ¹	HDBaseT port.

1 - Only for LSC521WU.

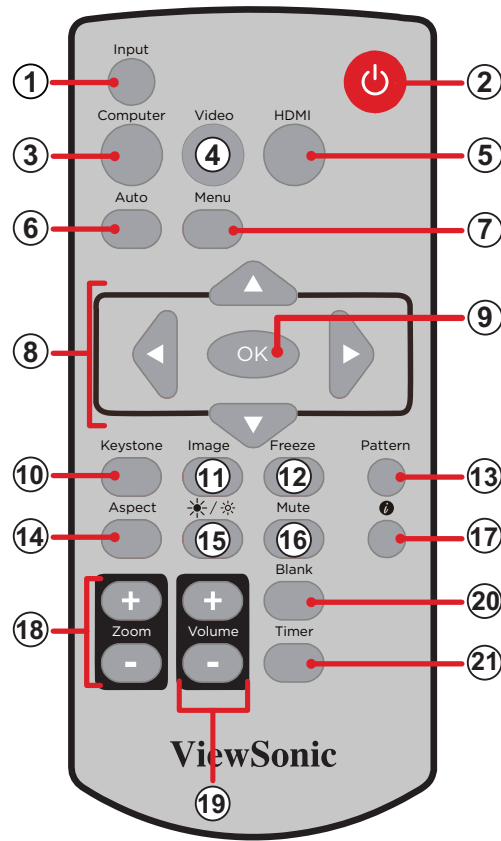
Remote Control



Button		Description
1	Input	Displays the source selection bar.
2		Turn the projector On or Off.
3	Computer	Selects the VGA input source.
4	Video	Selects the video input source.
5	HDMI	Selects the HDMI 1 or HDMI 2 input source.
6	Auto	Enter auto adjustment mode.
7	Menu	Turn on/off the On-Screen Display (OSD) Menu.
8	Navigational Buttons	Navigates and selects the desired menu items and make adjustments.
9	OK	Confirm the selection.
10	Keystone	Manually correct distorted images.
11	Image	Selects the image mode.

Button		Description
12	Freeze	Freeze the projected image.
13	Pattern	Displays embedded test pattern.
14	Aspect	Displays the aspect ratio selection bar.
15		Selects Light source mode.
16	Mute	Turn on or off the sound.
17		Display the current status and information of the projector.
18	Zoom	Increase or decrease the projected image size.
19	Volume	Increase or decrease the sound level.
20	Blank	Temporarily hides the projected image.
21	Timer	Enable the timer function.

Remote Control - Receiver Range

To ensure proper function of the remote control follow the steps below:

1. The remote control must be held at an angle within 30° perpendicular to the projector's IR remote control sensor(s).
2. The distance between the remote control and the sensor(s) should not exceed 6 m (19 ft).

NOTE: Refer to the illustration for the location of the infrared (IR) remote control sensor(s).

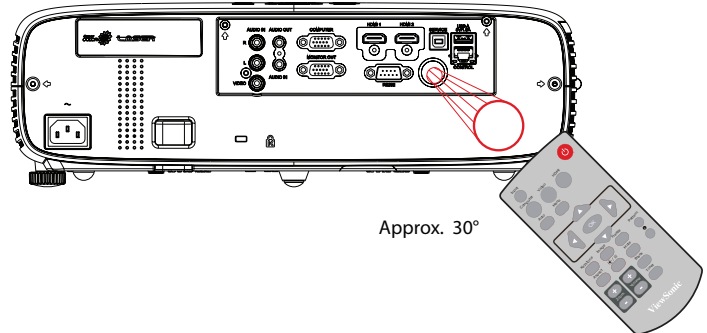
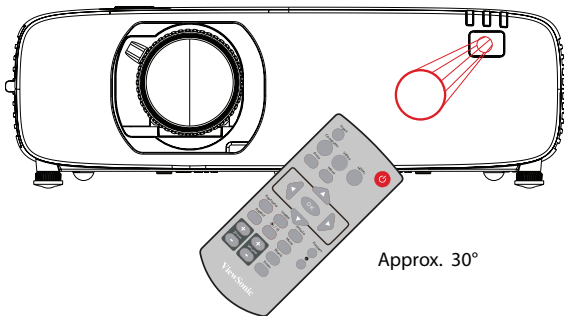

Remote Control - Replacing the Batteries

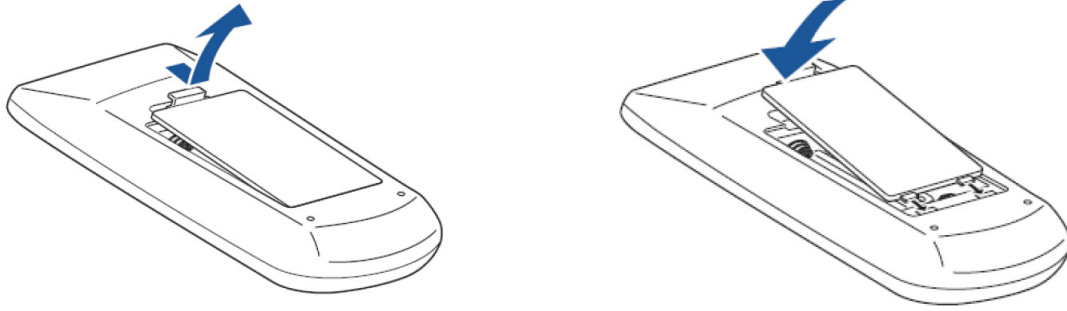

1. Remove the battery cover from the bottom of the remote control.
2. Remove any existing batteries (if necessary) and install two AAA batteries.
NOTE: Observe the battery's polarities as indicated.
3. Replace the battery cover by aligning it with the base and pushing it back into position.

NOTE:

- Avoid leaving the remote control and batteries in excessive heat or a humid environment.
- Replace only with the same or equivalent type recommended by the battery manufacturer.
- If the batteries are drained or if you will not be using the remote control for an extended period of time, remove the batteries to avoid damage to the remote control.
- Dispose of the used batteries according to the manufacturer's instructions and local environment regulations for your region.

Initial Setup

Choosing a Location - Projection Orientation

Personal preference and room layout will decide the installation location. Consider the following:

- Size and position of your screen.
- Location of a suitable power outlet.
- Location and distance between the projector and other equipment.

The projector is designed to be installed in one of the following locations:

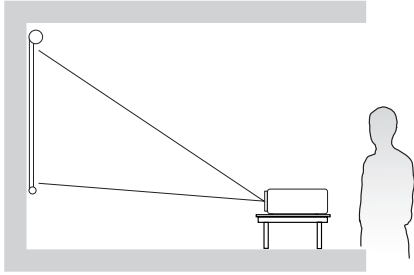
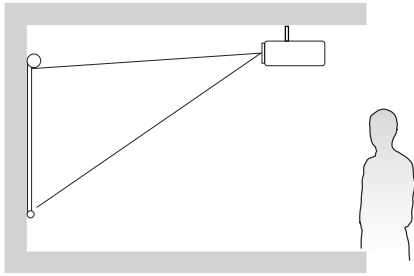
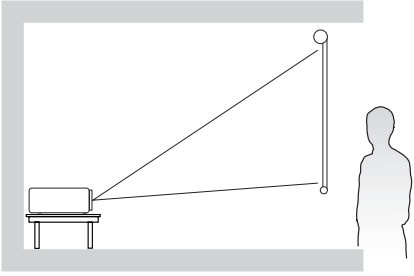
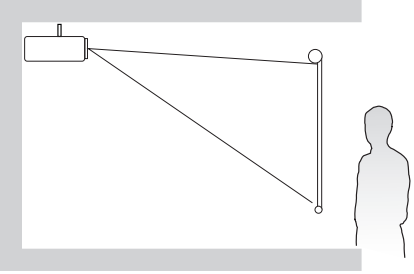
Location	
<p>Front</p> <p>The projector is placed near the floor in front of the screen.</p>	
<p>Ceiling Front</p> <p>The projector is suspended upside-down from the ceiling in front of the screen.</p>	
<p>Rear¹</p> <p>The projector is placed near the floor behind the screen.</p>	
<p>Ceiling Rear¹</p> <p>The projector is suspended upside-down from the ceiling behind the screen.</p>	

NOTE: When selecting **Auto Ceiling/Front** or **Auto Ceiling/Rear** as the projector position, the projector will be considered front projection automatically.

¹ A rear projection screen is required.

Projection Dimensions

LSC520WU

16:10 Image on a 16:10 Screen

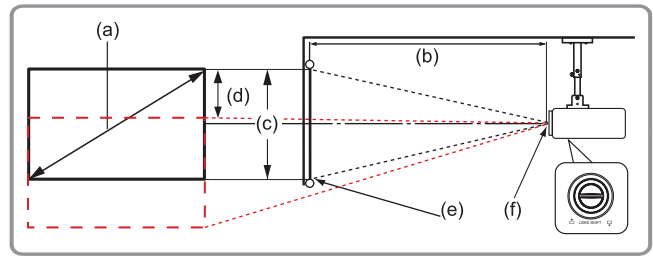
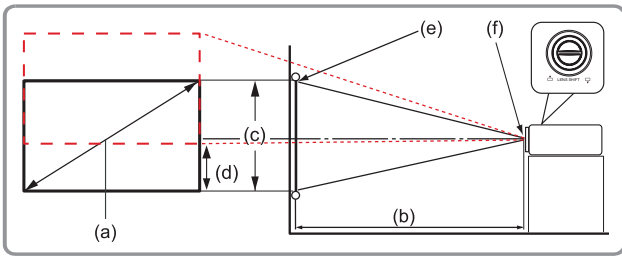

NOTE: (e) = Screen / (f) = Center of Lens

(a) Screen Size		(b) Projection Distance				(c) Image Height		(d) Vertical Offset	
		Minimum		Maximum					
in.	mm	in.	mm	in.	mm	in.	mm	in.	mm
30	762	26.76	680	44.15	1121	15.90	404	7.15	182
60	1524	54.68	1389	89.43	2272	31.80	808	14.31	363
70	1778	63.98	1625	104.53	2655	37.10	942	16.69	424
80	2032	73.28	1861	119.62	3038	42.40	1077	19.08	485
90	2286	82.59	2098	134.72	3422	47.70	1212	21.46	545
100	2540	91.89	2334	149.82	3805	53.00	1346	23.85	606
120	3048	110.50	2807	180.01	4572	63.60	1615	28.62	727
150	3810	138.41	3516	225.29	5722	79.50	2019	35.77	909
180	4572	166.33	4225	270.58	6873	95.40	2423	42.93	1090
200	5080	184.94	4697	300.77	7640	106.00	2692	47.70	1212
250	6350	231.46	5879	376.25	9557	132.50	3365	59.62	1514
300	7620	277.98	7061	451.73	11474	159.00	4039	71.55	1817

NOTE:

- These figures are for reference purposes only. Please refer to the actual projector for the precise dimensions.
- It is recommended that if you intend to permanently install the projector to physically test the projection size and distance using the actual projector before you permanently install it.

16:10 Image on a 4:3 Screen

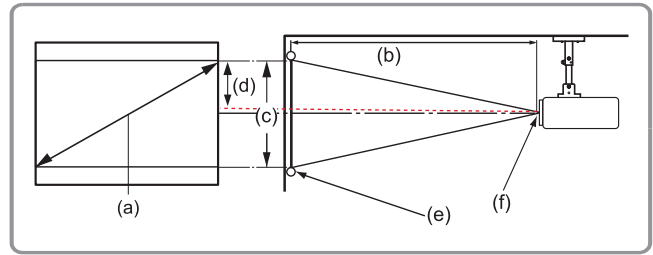
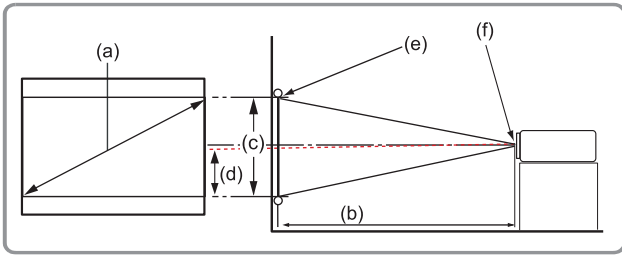

NOTE: (e) = Screen / (f) = Center of Lens

(a) Screen Size		(b) Projection Distance				(c) Image Height		(d) Vertical Offset	
		Minimum		Maximum					
in.	mm	in.	mm	in.	mm	in.	mm	in.	mm
30	762	25.91	658	42.24	1073	15.00	381	6.73	171
60	1524	51.73	1314	84.33	2142	29.96	761	13.48	342
70	1778	60.43	1535	98.50	2502	34.96	888	15.73	400
80	2032	69.11	1755	112.64	2861	39.98	1015	17.99	457
90	2286	77.74	1975	126.72	3219	44.98	1142	20.24	514
100	2540	86.38	2194	140.80	3576	49.97	1269	22.49	571
120	3048	103.66	2633	168.96	4292	59.97	1523	26.99	685
150	3810	129.57	3291	211.20	5364	74.96	1904	33.73	857
180	4572	155.49	3949	253.44	6437	89.95	2285	40.48	1028
200	5080	172.76	4388	281.60	7153	99.94	2539	44.98	1142
250	6350	215.96	5485	352.00	8941	124.93	3173	56.22	1428
300	7620	259.15	6582	422.40	10729	149.92	3808	67.46	1714

NOTE:

- These figures are for reference purposes only. Please refer to the actual projector for the precise dimensions.
- It is recommended that if you intend to permanently install the projector to physically test the projection size and distance using the actual projector before you permanently install it.

LSC521WU

16:10 Image on a 16:10 Screen

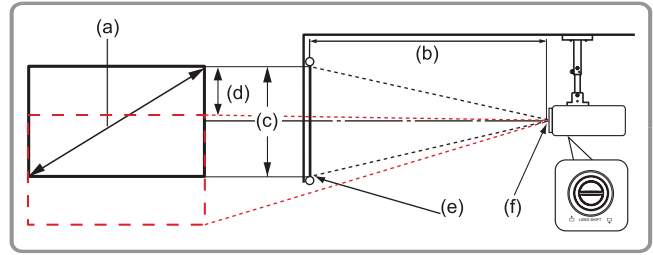
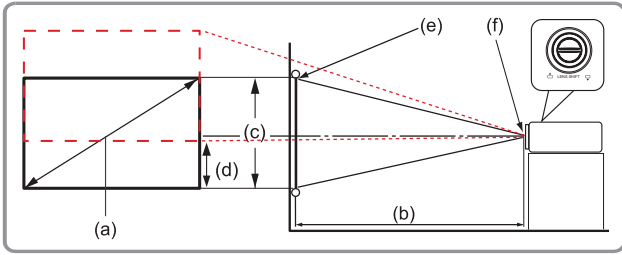

NOTE: (e) = Screen / (f) = Center of Lens

(a) Screen Size		(b) Projection Distance				(c) Image Height		(d) Vertical Offset	
		Minimum		Maximum					
in.	mm	in.	mm	in.	mm	in.	mm	in.	mm
30	762	30.10	765	49.54	1258	16	404	9.54	242
60	1524	61.59	1564	100.40	2550	32	808	19.08	485
70	1778	72.09	1831	117.35	2981	37	942	22.26	565
80	2032	82.59	2098	134.31	3411	42	1077	25.44	646
90	2286	93.09	2364	151.26	3842	48	1212	28.62	646
100	2540	103.58	2631	168.21	4273	53	1346	31.80	808
120	3048	124.58	3164	202.12	5134	64	1615	38.16	969
150	3810	156.07	3964	252.98	6426	79	2019	47.70	1212
180	4572	187.56	4764	303.85	7718	95	2423	57.24	1454
200	5080	208.56	5297	337.75	8579	106	2692	63.60	1615
250	6350	261.05	6631	422.52	10732	132	3365	79.50	2019
300	7620	314	7964	507.29	12885	159	4039	95.40	2423

NOTE:

- These figures are for reference purposes only. Please refer to the actual projector for the precise dimensions.
- It is recommended that if you intend to permanently install the projector to physically test the projection size and distance using the actual projector before you permanently install it.

16:10 Image on a 4:3 Screen

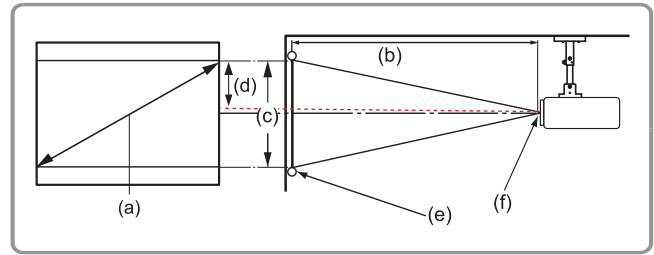
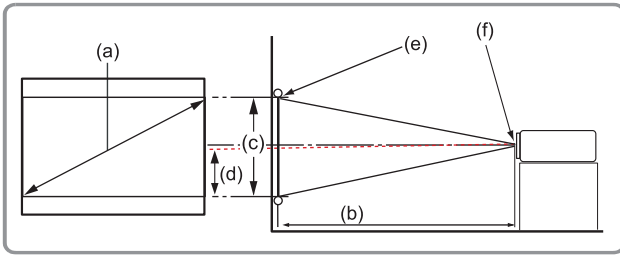

NOTE: (e) = Screen / (f) = Center of Lens

(a) Screen Size		(b) Projection Distance				(c) Image Height		(d) Vertical Offset	
		Minimum		Maximum					
in.	mm	in.	mm	in.	mm	in.	mm	in.	mm
30	762	28.82	732	48.23	1225	15.00	381	9.00	229
60	1524	57.60	1463	96.50	2451	30.00	762	18.00	457
70	1778	67.20	1707	112.56	2859	35.00	889	21.00	533
80	2032	76.81	1951	128.62	3267	40.00	1016	24.00	610
90	2286	86.41	2195	144.70	3675	45.00	1143	27.00	686
100	2540	96.01	2439	160.78	4084	50.00	1270	30.00	762
120	3048	115.22	2926	192.93	4900	60.00	1524	36.00	914
150	3810	144.02	3658	241.17	6126	75.00	1905	45.00	1143
180	4572	172.82	4390	289.40	7351	90.00	2286	54.00	1372
200	5080	192.03	4877	321.55	8167	100.00	2540	60.00	1524
250	6350	240.03	6097	401.94	10209	125.00	3175	75.00	1905
300	7620	288.04	7316	482.33	12251	150.00	3810	90.00	2286

NOTE:

- These figures are for reference purposes only. Please refer to the actual projector for the precise dimensions.
- It is recommended that if you intend to permanently install the projector to physically test the projection size and distance using the actual projector before you permanently install it.

Mounting the Projector

NOTE: If you buy a third party mount, please use the correct screw size. Screw size can vary depending on the thickness of the mounting plate.

1. To ensure the most secure installation, please use a ViewSonic® wall or ceiling mount.
2. Ensure the screws used to attach the mount to the projector meet the following specifications:
 - Screw type: M4 x 8
 - Maximum Screw Length: 8 mm

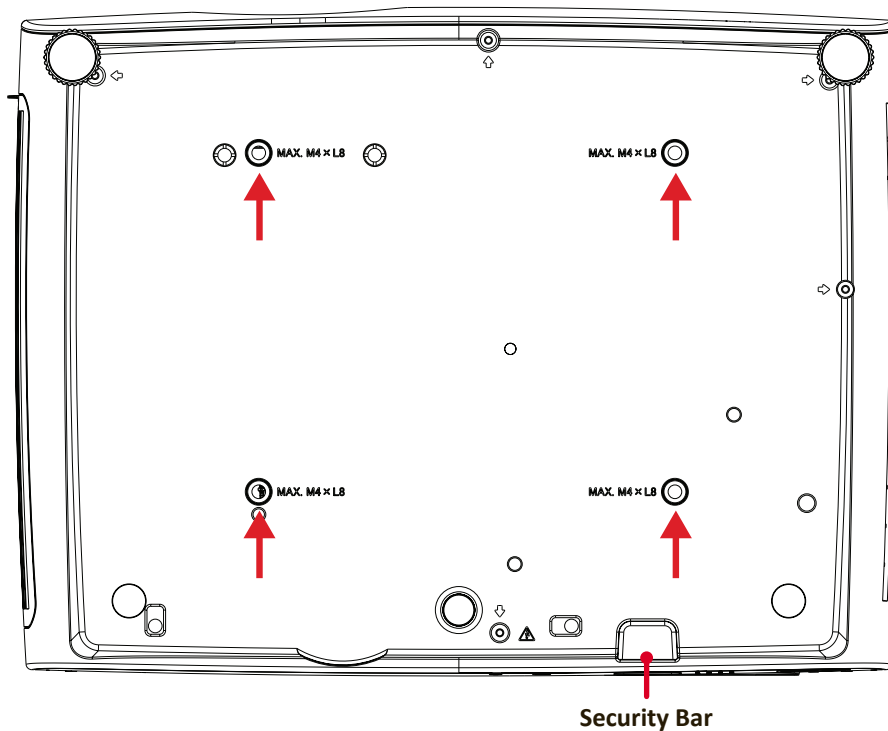

CAUTION:

- Avoid installing the projector near a heat source or air conditioner.
- Keep at least a 50 cm (19.6 in.) gap between the ceiling and the bottom of the projector.

Using the Security Bar

To help prevent the projector from being stolen, use a security slot locking device to secure the projector to a fixed object.

Making Connections

Connecting to Power

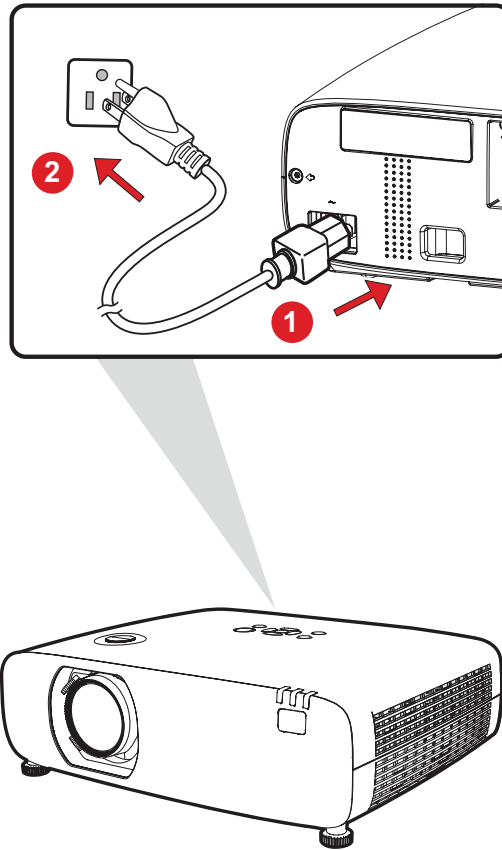

1. Connect the power cord to the AC IN socket at the rear of the projector.
2. Plug the power cord into a power outlet.

NOTE: When installing the projector, incorporate a readily accessible disconnect device in the fixed wiring, or connect the power plug to an easily accessible outlet near the unit. If a fault should occur during operation of the projector, use the disconnect device to switch off the power supply, or disconnect the power plug.

Connecting to External Devices

VGA Connection

Connect one end of a VGA cable to the VGA port of the computer. Then connect the other end of the cable to the **COMPUTER** port of the projector.

NOTE: Some computers do not turn on their external displays automatically when connected to a projector. You may have to adjust your computer's projection settings.

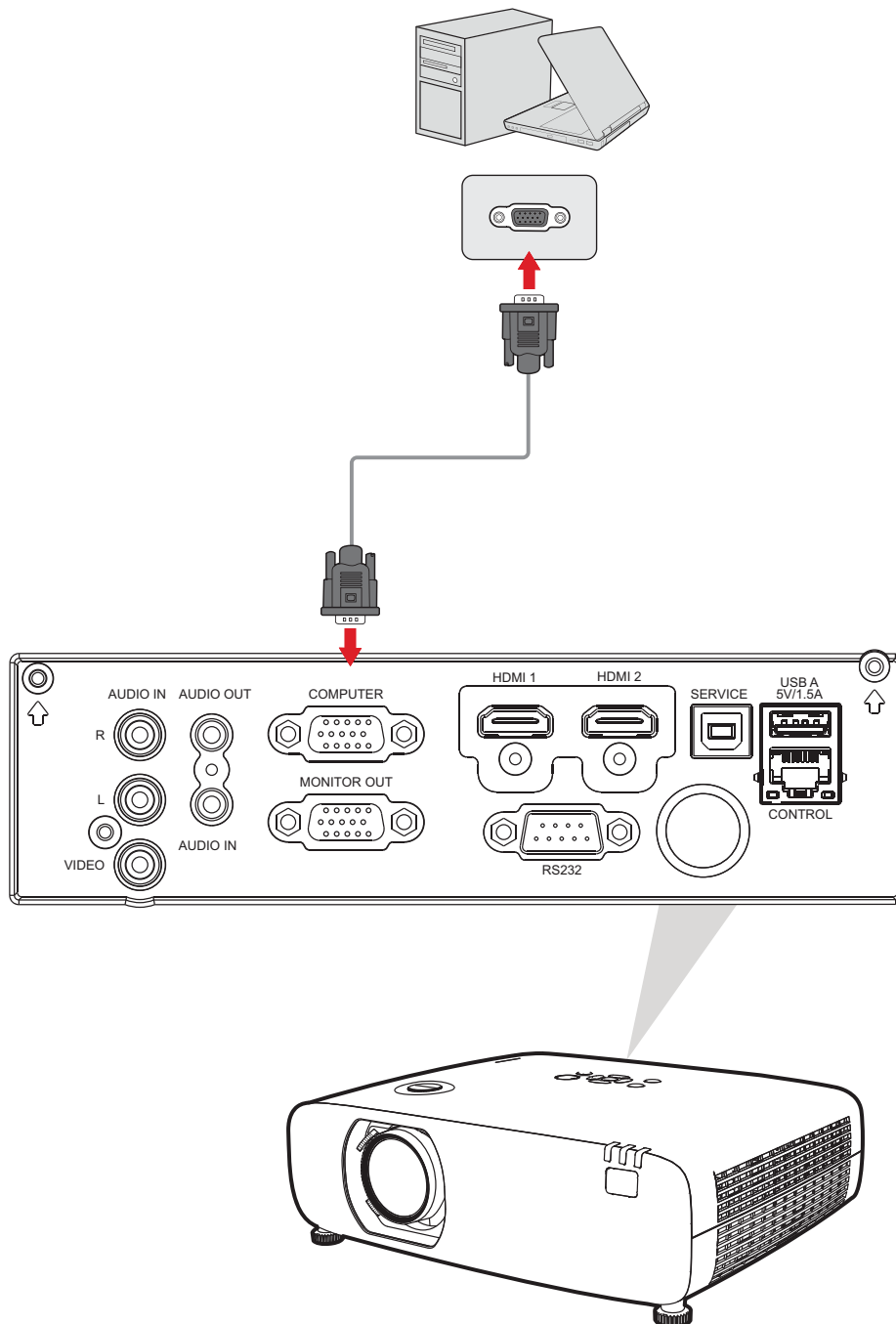

VGA Out Connection

To view the projected content up close on a monitor as well as project it, a monitor can be connected to the **MONITOR OUT** port of the projector.

After establishing the VGA Connection, connect one end of a VGA cable to the VGA port of your monitor. Then connect the other end of the cable to the **MONITOR OUT** port of your projector.

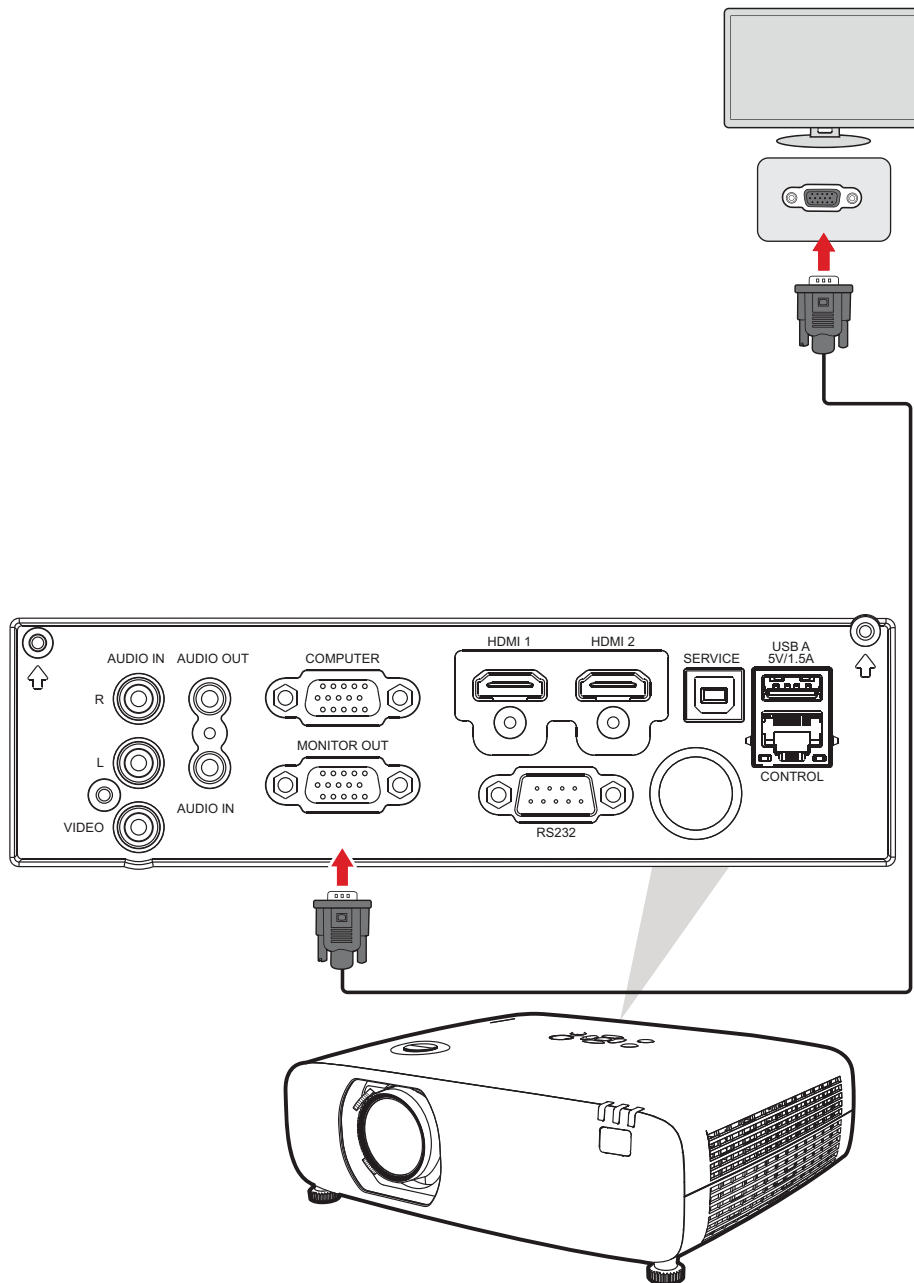

Composite Video Connection

Connect one end of a Video cable to the Video port of your video device. Then connect the other end of the cable to the **VIDEO** port of your projector.

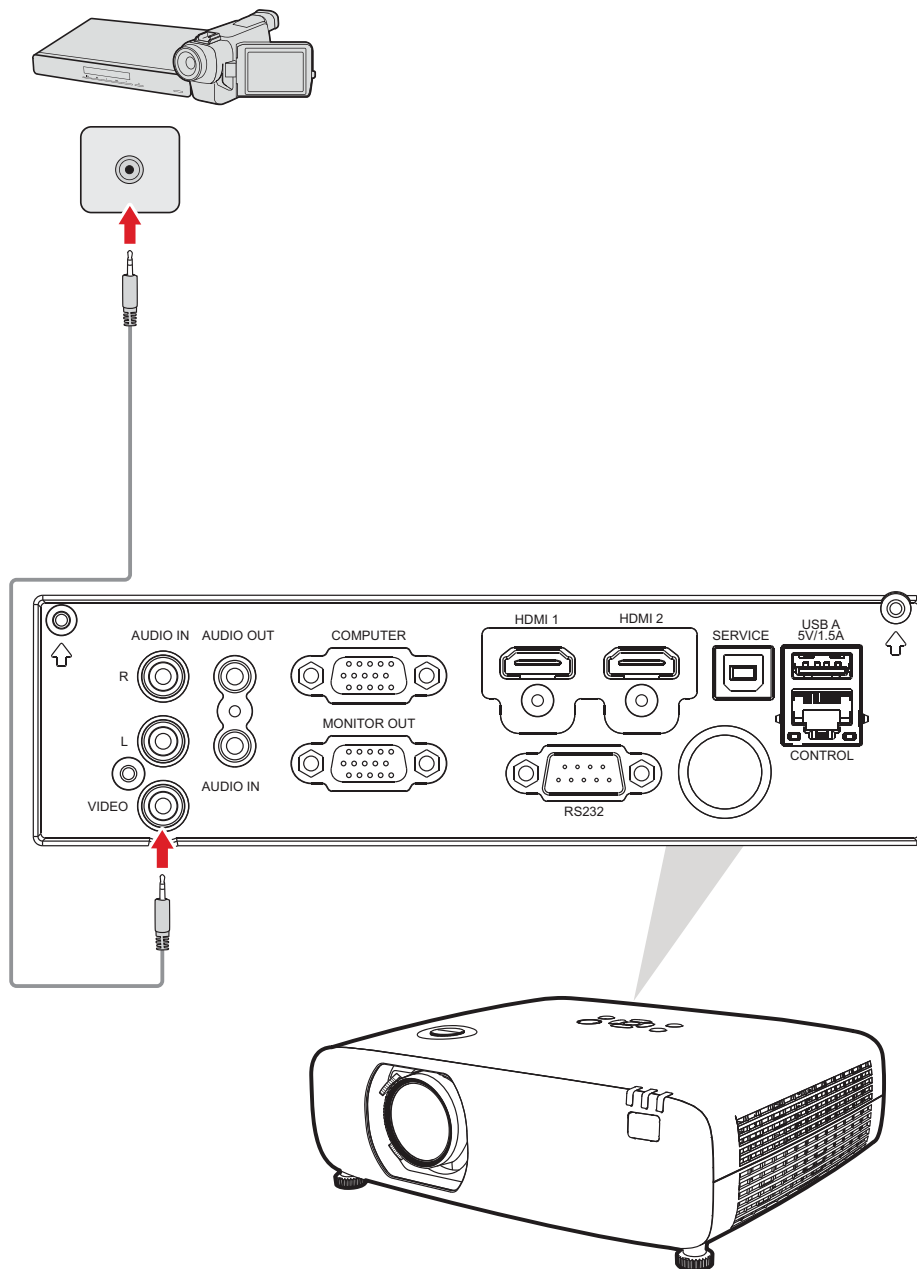

HDMI Connection

Connect one end of an HDMI cable to the HDMI port of your video device. Then connect the other end of the cable to the **HDMI 1** or **HDMI 2** port of your projector.

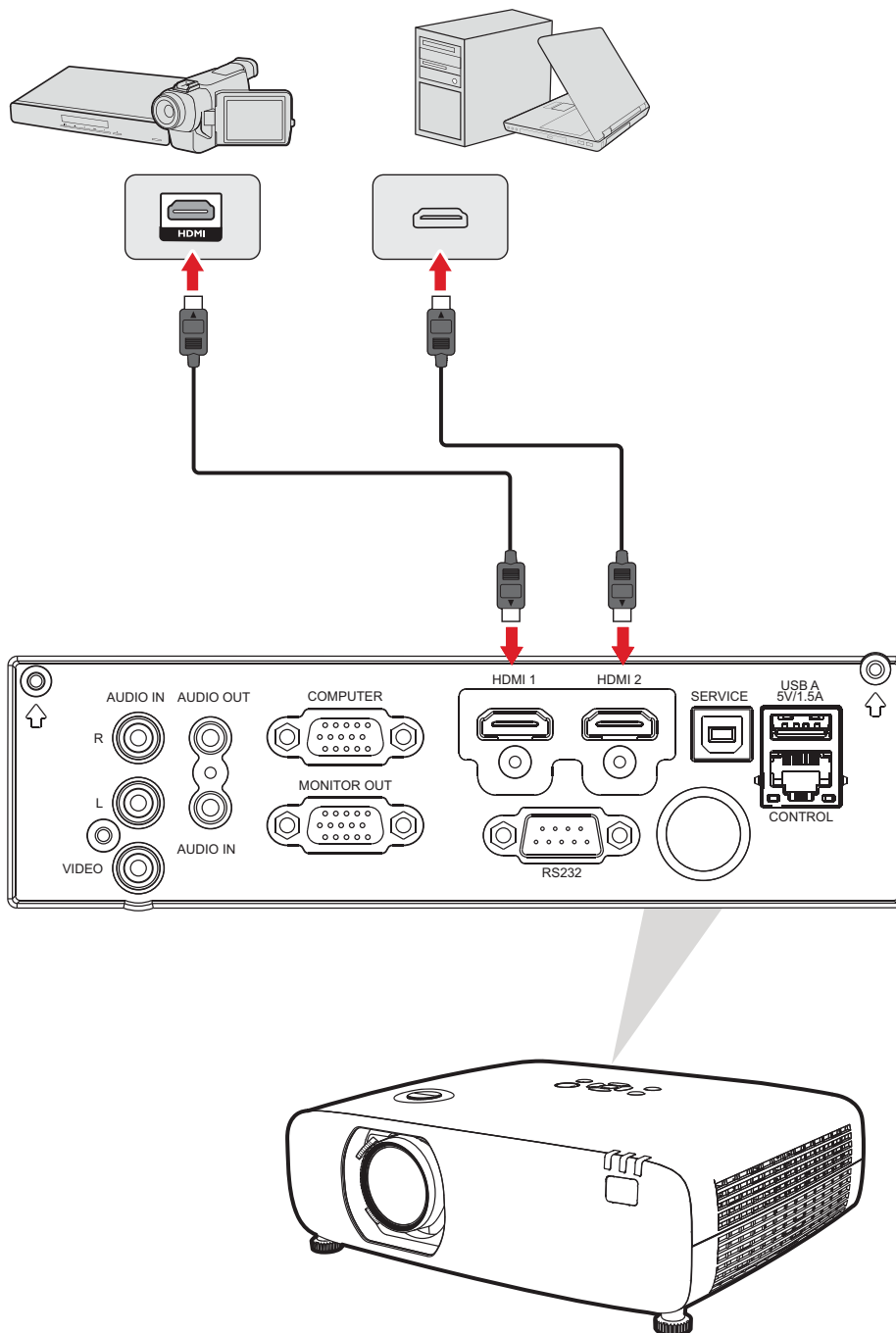

Audio Connection

The projector supports both Audio In and Audio Out.

Audio In

To play audio from your external device through the projector's speakers, connect one end of an audio cable to your external device, and the other end to the projector's **AUDIO IN** port.

Audio Out

To play audio from the projector through an external speaker, connect one end of an audio cable to the external speaker, and the other end to the projector's **AUDIO OUT** port.

R/L Audio In

To play audio from your external device through the projector's speakers, connect one end of an audio cable to your external device, and the other end to the projector's **R/L AUDIO IN** ports.

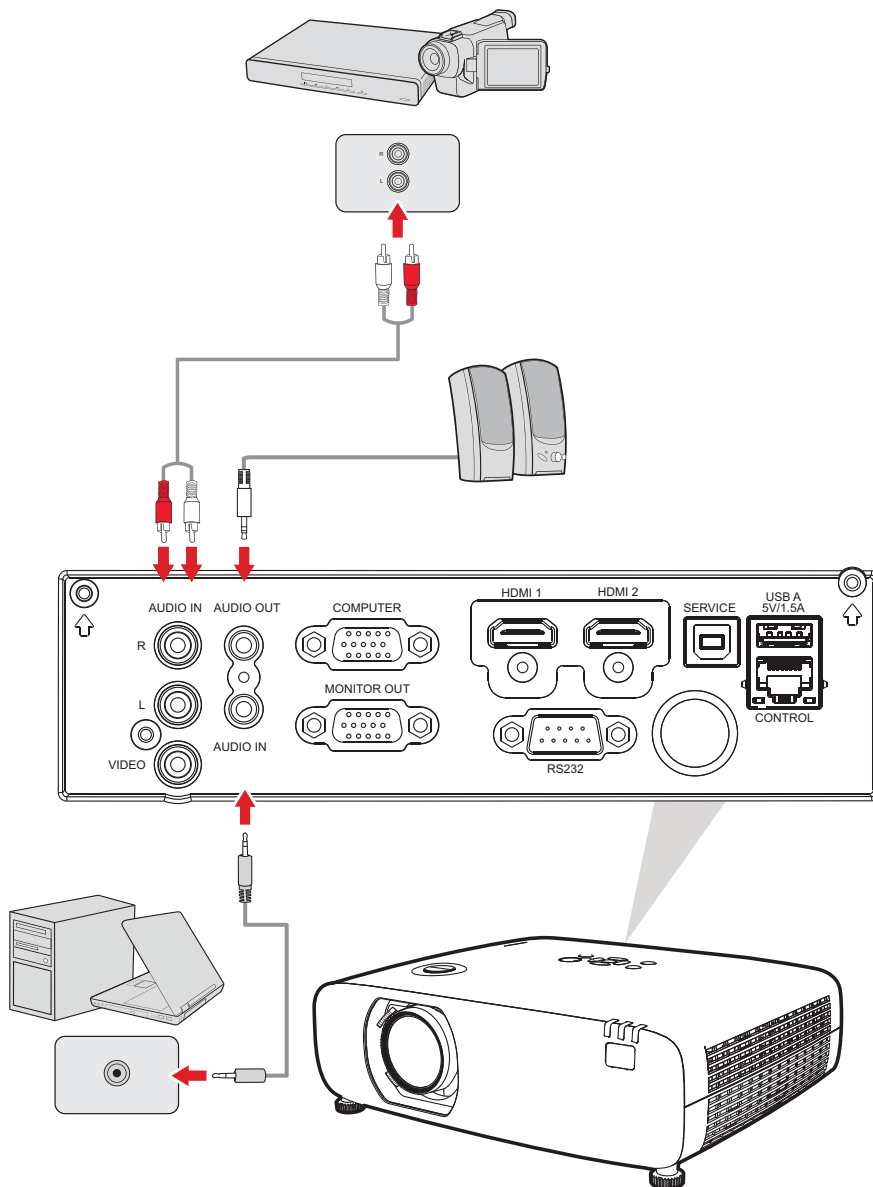

USB Connection

USB Type A

The USB Type A port is for reader (FAT32) and supplying power.

USB Type B

The USB Type B port is for service and USB display.

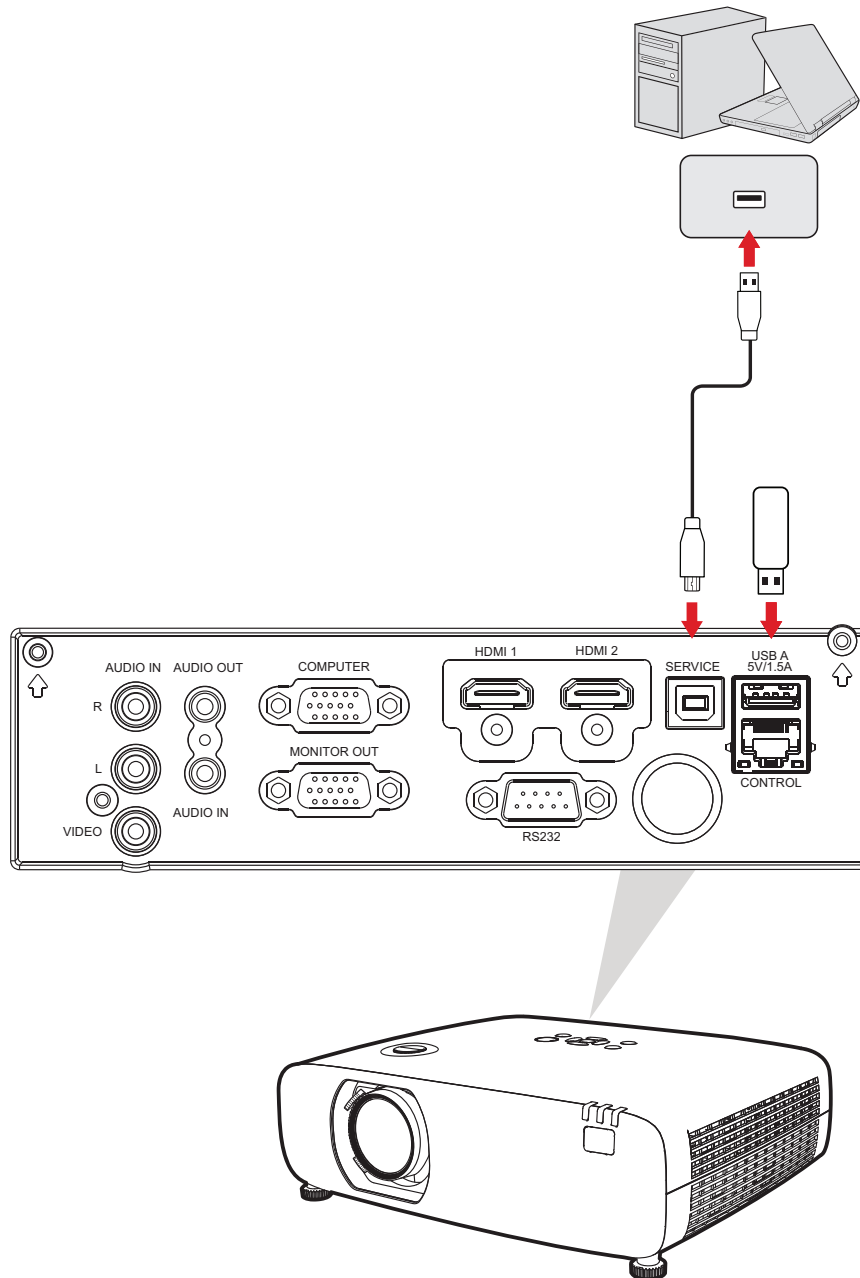

USB Display

USB Display will output the computer's audio and image.

1. Connect one end of a USB Type B cable to the USB port of your computer. Then connect the other end of the cable to the **SERVICE** port of your projector.
2. Once connected, the computer will automatically detect the pwPresenter driver from the projector. Select autorun.exe to install the driver.
3. On the remote control, press the **Input** button and select **USB B** from the input source menu to display the computer's image.

Network Connection

Plug the network cable into the **CONTROL** port for network connectivity.

The projector provides several networking and remote management features. The LAN /RJ45 function of the projector, through a network, can control the projector remotely.

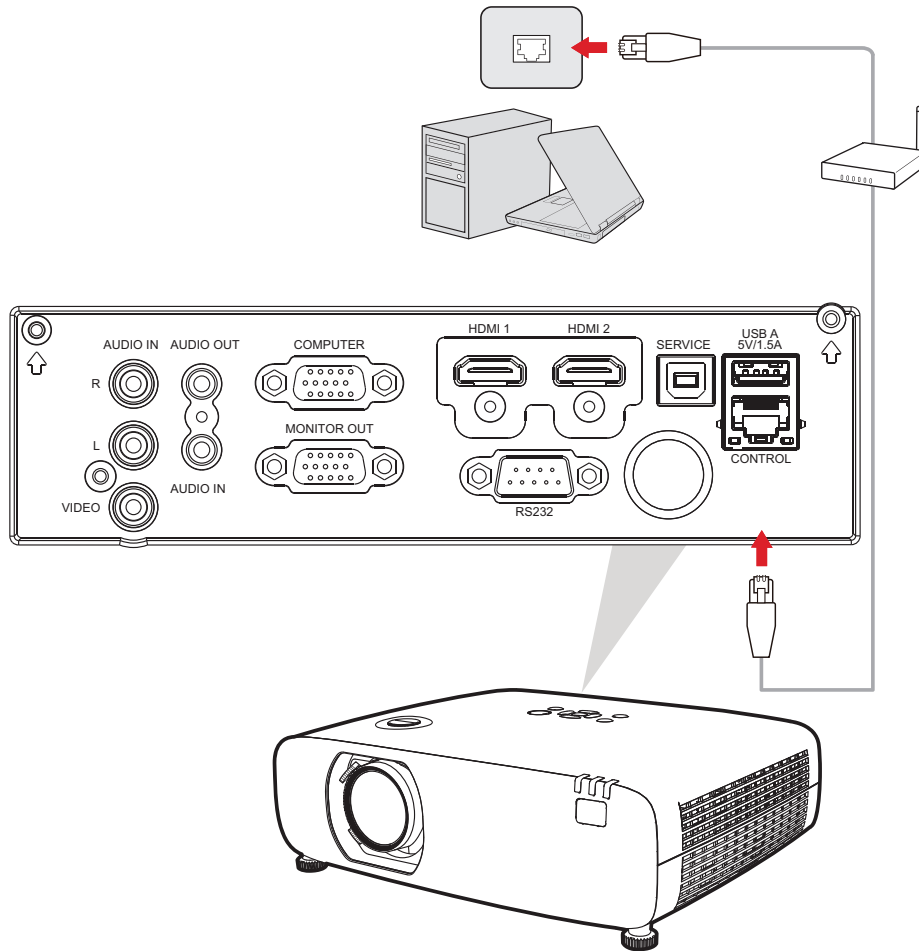

RS-232 Connection

When you use a RS-232 serial port cable to connect the projector to an external computer certain functions can be controlled remotely by the PC, including Power On/Off, Volume adjustment, Input select, Brightness, and more.

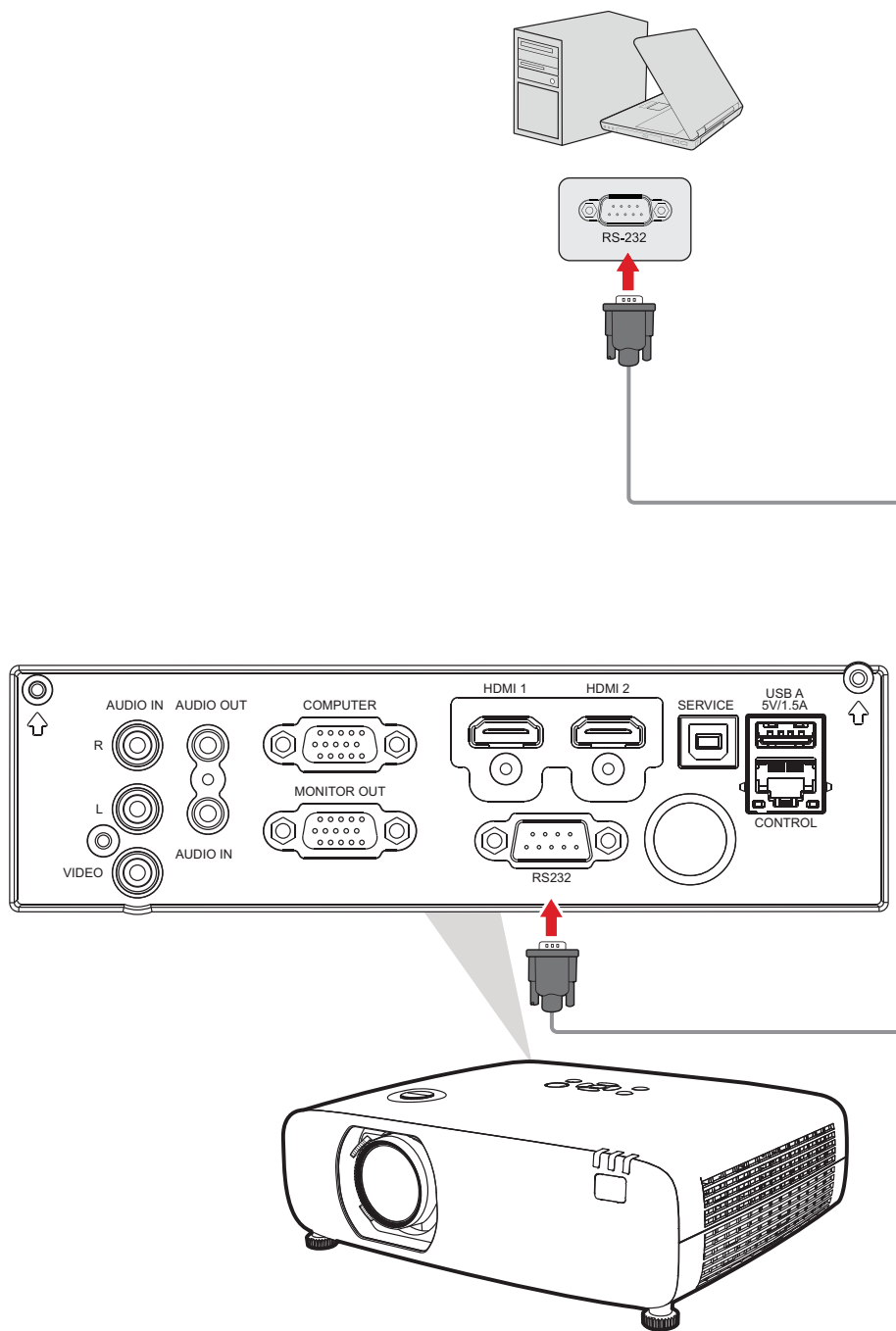

HDBaseT Connection

NOTE: HDBaseT is only available for LSC521WU.

HDBaseT is a technology to transmit image signal through a LAN cable.

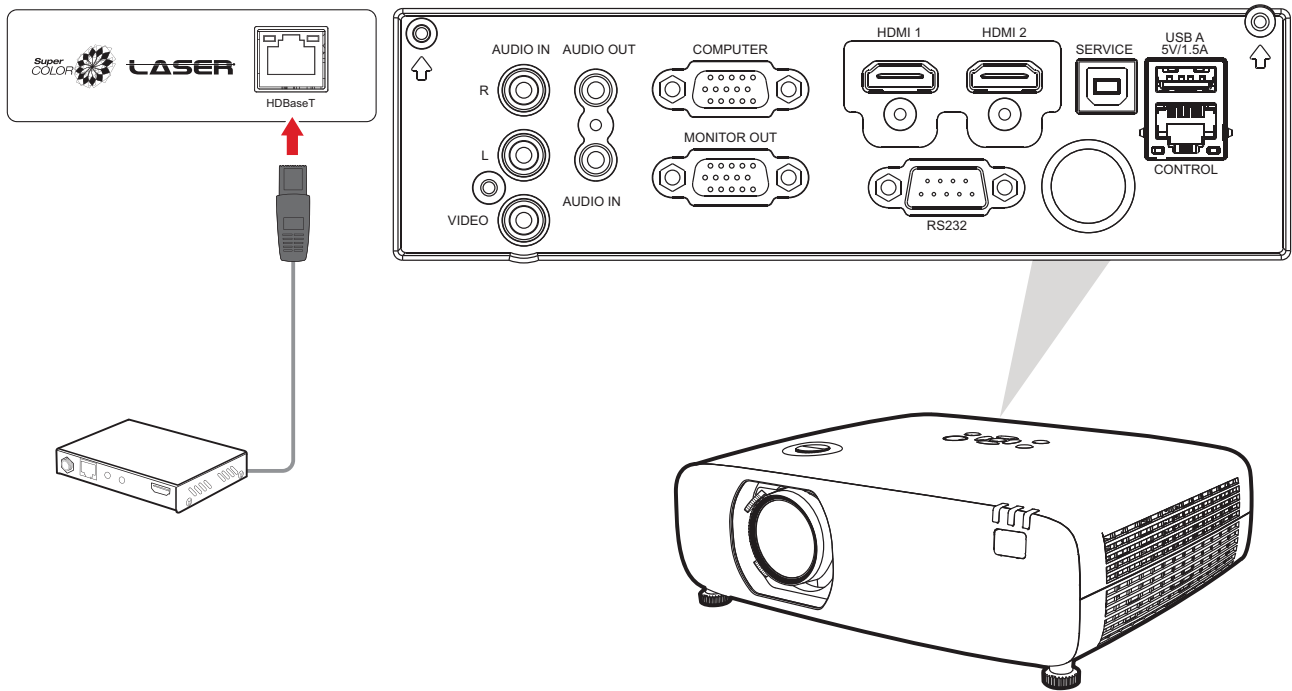

Using the Projector

Turning the Projector On

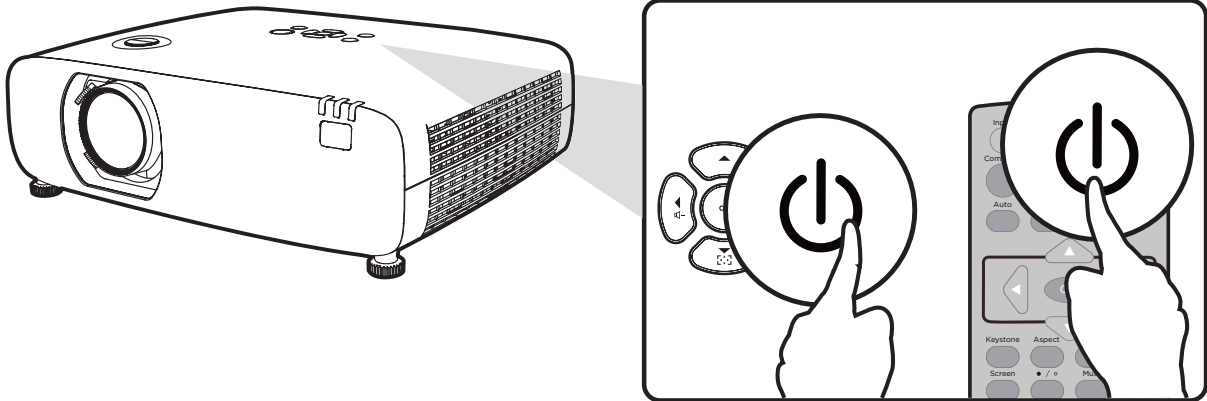

1. Make sure the projector's power cord is properly connected to a power outlet.
2. Press the **Power** button on the projector or remote control to turn on the projector.

NOTE:

- The Power Indicator Light will be flashing orange during startup.
- The first time the projector is turned on, you will be prompted to select the preferred language and projection orientation.

Adjusting the Projected Image

Adjusting the Projector's Height and Projection Angle

The projector is equipped with two adjustment feet. Adjusting the feet will change the projector's height and the vertical projection angle.

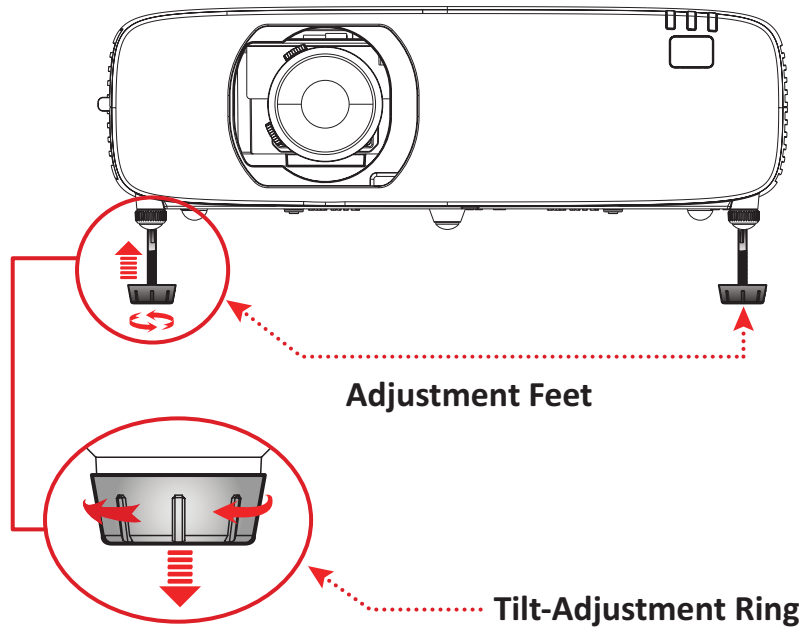

Adjusting the Focus, Keystone, and Lens Shift

You can improve and adjust the clarity and position of the image by adjusting the **Focus Ring**, **Lens Shift** dial, or **Zoom Ring**.

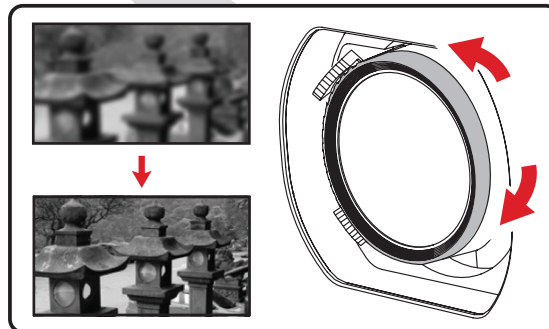
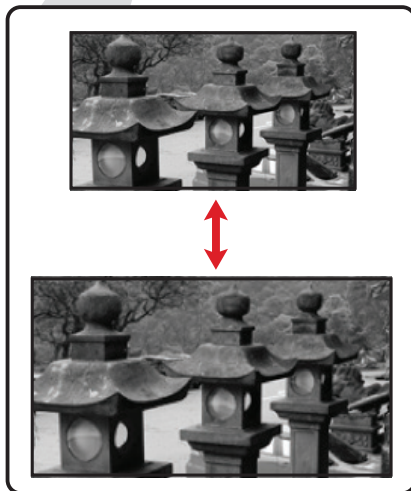
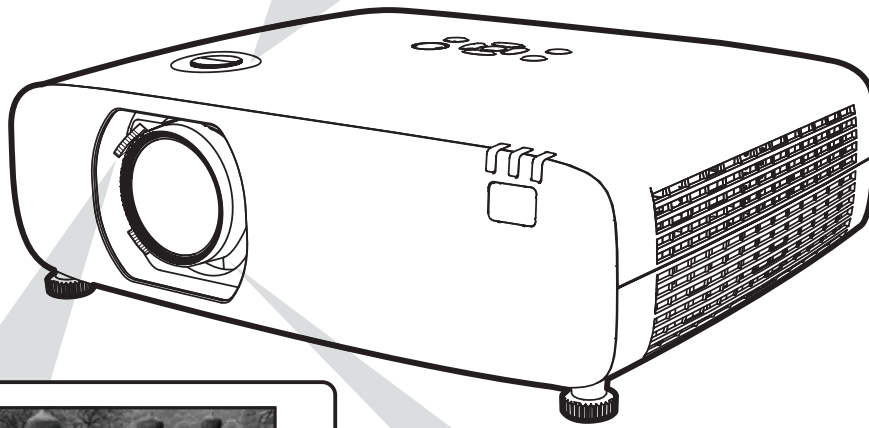
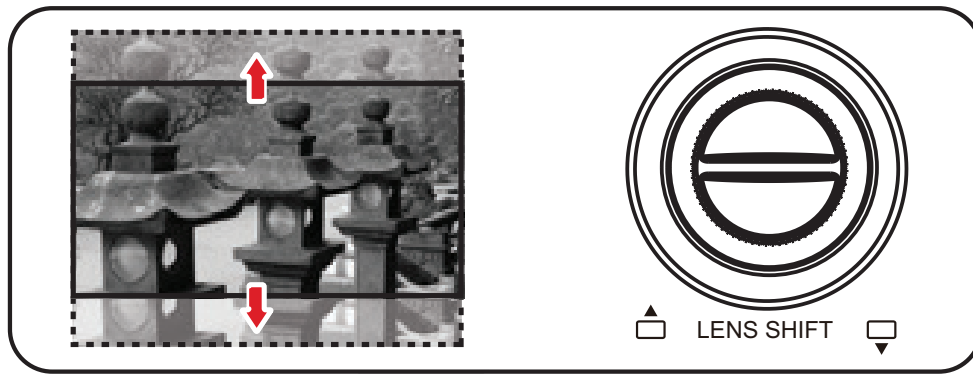

Turning the Projector Off





1. Press the **Power** button on the projector or remote control and a “power off message” will appear.
2. Press the **Power** button again to confirm and shut down the projector.
3. The Power Indicator Light will flash orange and enter standby mode.

Menu Operation

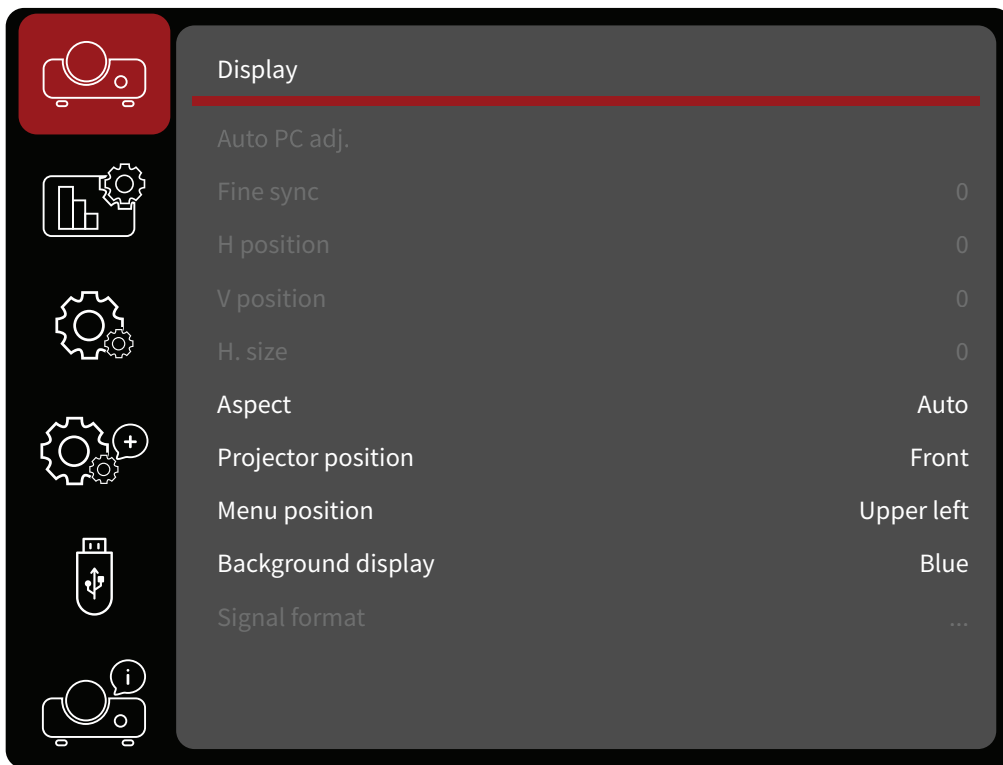
On-Screen Display (OSD) Menu

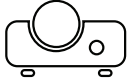
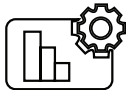
The projector has multilingual on-screen display menus that allow you to make image adjustments and change a variety of settings.



Menu		Description
Display		Adjust image position, Aspect, Projector and Menu Position, Background Display, and Signal Format settings.
Image Settings		Adjust Image Mode, Contrast, Brightness, and other image settings.
Settings		Adjust Direct Power On, Standby Mode, High Altitude Mode, Cooling Fast, Closed Caption, Key Lock, Baud Rate, Volume, and HDMI Setup.
Advanced		Adjust Language, Auto Setup, Keystone, Logo, Security, Power Management, Filter, Test Pattern, and Network Setup settings.
USB A		Adjust slide, transition, slide order, and other settings when a USB Type A storage device is connected to the projector.
Information		View projector information.

Menu Navigation

The projector has multilingual on-screen display menus that allow for image and settings adjustment.

1. To open the On-Screen Display (OSD) Menu, press the **Menu** button on the projector or the remote control.
2. When the OSD is displayed, use the **Navigation** buttons (**▲/▼**) to select any item in the main menu. While making a selection on a particular page, press the **OK** button on the projector or the remote control to enter a sub-menu.
3. Use the **Navigation** buttons (**▲/▼/◀/▶**) to select the desired item in the sub-menu and then press **OK** to view further settings. Adjust the settings by using the **Navigation** buttons (**▲/▼/◀/▶**).
4. Select the next item to be adjusted in the sub-menu and adjust as described above.
5. Press **OK** to confirm, and the screen will return to the main menu.
6. To exit, press the **Menu** button again. The OSD menu will close and the projector will automatically save the new settings.

On-Screen Display (OSD) Menu Tree

Main Menu	Sub-menu	Menu Option		
Display	Auto PC Adj.			
	Fine Sync			
	H Position	(-5~+5)		
	V Position	(-5~+5)		
	H Size	(-15~+15)		
	Aspect	Auto		
		16:9		
		16:10		
		4:3		
		21:9		
		Advanced		
	Projector Position	Front		
		Rear		
		Ceiling / Front		
		Ceiling / Rear		
		Auto Ceiling / Front		
		Auto Ceiling / Rear		
	Menu Position	Upper Left		
		Upper Right		
		Center		
Lower Left				
Lower Right				
Background Display	Black			
	Blue			
Signal Format				

Main Menu	Sub-menu	Menu Option	
Image Settings	Image Mode	Standard	
		Cinema	
		Golf	
		Colorboard	
		User	
		Brightest	
	Dynamic Mode	Off	
		Mode 1	
		Mode 2	
		Mode 3	
	Contrast	(0~63)	
	Brightness	(0~63)	
	Color Temp	High	
		Mid	
		Low	
		User	
	Color	(0~63)	
	Tint	(0~63)	
	Red	(0~63)	
	Green	(0~63)	
	Blue	(0~63)	
	Sharpness	(0~15)	
	Advanced Color Adj.	Hue/Saturation/Gain	
Yellow			
Green			
Cyan			
Blue			
Magenta			
Reset			

Main Menu	Sub-menu	Menu Option		
Settings	Direct Power On	On		
		Off		
	Standby Mode	Normal		
		ECO		
		Network		
	High Altitude Mode	On		
		Off		
		Auto		
	Cooling Fast	Normal		
		30 sec		
		0 sec		
	Closed Caption	Off		
		CC1		
		CC2		
		CC3		
		CC4		
	Key Lock	On		
		Off		
	Baud Rate	19200		
		4800		
		38400		
		9600		
	Laser Control	Light Source Mode		Normal
				Full
				ECO1
				ECO2
	Sound	Volume		(0~25)
		Mute		On
Off				
HDMI Setup	Image	Auto		
		(64~940)		
		(0~1023)		
	Sound	HDMI		
		Computer		
HDMI EQ Settings	0/1/2/3			

Main Menu	Sub-menu	Menu Option	
Advanced	Language	English Deutsch Français Italiano Español Português Nederlands Svenska Suomi Norsk Dansk Polski Český Magyar Русский Türkçe Қазақ Tiếng Việt 한국어 日本語 ไทย 中文繁體 中文 Bahasa Indonesia ىسراف	
	Auto Setup	Input Search	On
			Off
		Auto PC Adj.	On
			Off
		Auto Keystone	On
			Off
	Manual		
	Keystone	Keystone	Store
			Reset
		H/V Keystone	
		4-Corner Correction	
		6-Corner Correction	
		Curved Correction	
		Grid Image Tune	
	Reset Value		

Main Menu	Sub-menu	Menu Option		
Advanced	Logo	Logo Select	Default	
			User	
			Off	
		Capture		
		Logo PIN Code Lock	On	
			Off	
	Logo PIN Code Change			
	Security	PIN Code Lock	On	
			Off	
	Power Management	PIN Code Change		
		Ready		
		Shutdown		
		Off		
		Timer		(1~30 min)
		Ready Countdown		(0~30 min)
	Filter Counter	Timer	Off	
			500H	
			1000H	
			2000H	
		Filter Counter Reset		
		Filter Status	On	
	Off			
	Test Pattern			
Network Setup				
Factory Default				
USB-A	Set Slide			
	Slide Transition Effect			
	Sort Order			
	Rotate			
	Best Fit			
	Repeat			
	Apply			

Main Menu	Sub-menu	Menu Option
Information	Input	
	H-Sync Freq.	
	V-Sync Freq.	
	Light Source Counter	
	MAC Address	
	S/N	
	Firmware Version	
	SUBCPU	

Menu Options

Display

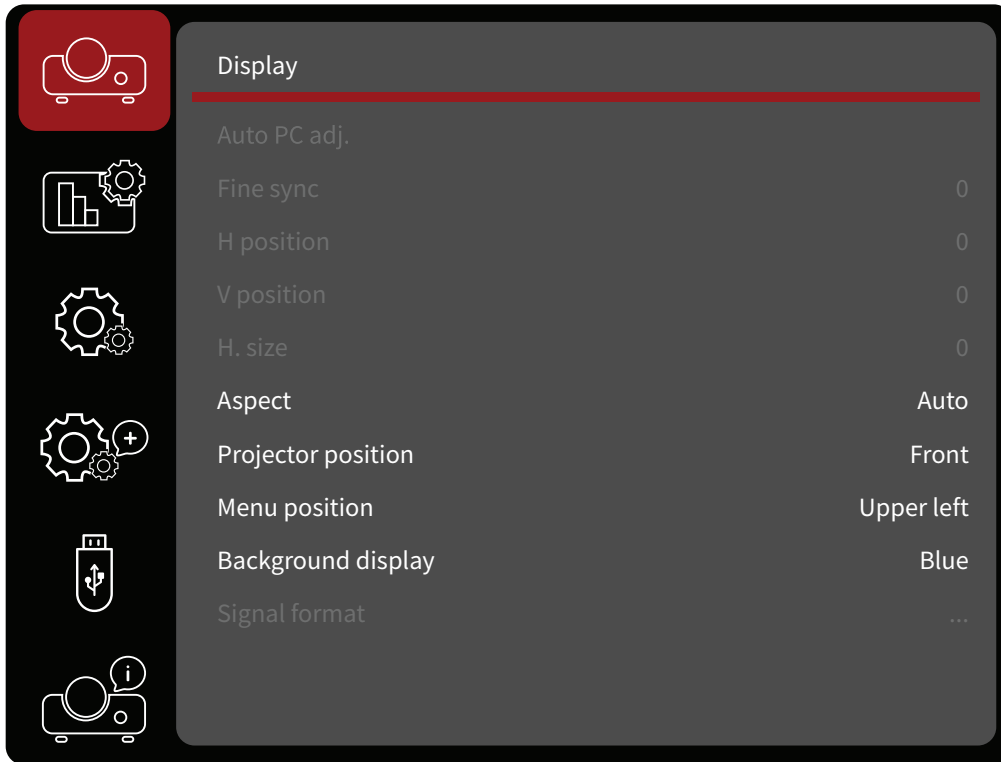

Menu	Description
Auto PC Adj.	Automatically adjust the best picture timings for the projected image. NOTE: For the PC input signal only.
Fine Sync	Manually adjust the picture timings for the projected image. NOTE: For the PC input signal only.
H Position	Manually set the horizontal position of the projected image. NOTE: <ul style="list-style-type: none"> • For the PC input signal only. • The adjustment range may vary depending on the display timings.
V Position	Manually set the vertical position of the projected image. NOTE: <ul style="list-style-type: none"> • For the PC input signal only. • The adjustment range may vary depending on the display timings.
H. Size	Manually set the horizontal width of the projected image. NOTE: For the PC input signal only.

Menu	Description
Aspect	<p><u>Auto</u></p> <p>Scales an image proportionally to fit the projector's native resolution in its horizontal width. This is suitable for the incoming image which is neither in 4:3 nor 16:9 and you want to make most use of the screen without altering the image's aspect ratio.</p> <p><u>16:9</u></p> <p>Scales an image so that it is displayed in the center of the screen with a 16:9 aspect ratio. This is most suitable for images which are already in a 16:9 aspect, like high definition TV, as it displays them without aspect alteration.</p> <p><u>16:10</u></p> <p>Scales an image so that it is displayed in the center of the screen with a 16:10 aspect ratio. This is most suitable for images which are already in a 16:10 aspect, as it displays them without aspect alteration.</p> <p><u>4:3</u></p> <p>Scales an image so that it is displayed in the center of the screen with a 4:3 aspect ratio. This is most suitable for 4:3 images like computer monitors, standard definition TV, and 4:3 aspect DVD movies, as it displays them without aspect alteration.</p> <p><u>21:9</u></p> <p>Scales an image for a MTR application.</p> <p><u>Advanced</u></p> <p>Advanced aspect ratio settings for screen partitioning.</p>
Projector Position	Select the projection position of the projector.
Menu Position	Set the On-Screen Display (OSD) Menu's position on screen.
Background Display	Set the background color.
Signal Format¹	Set the projection area's display color.

¹ - Not available for USB reader, USB display, or LAN display.

Image Settings

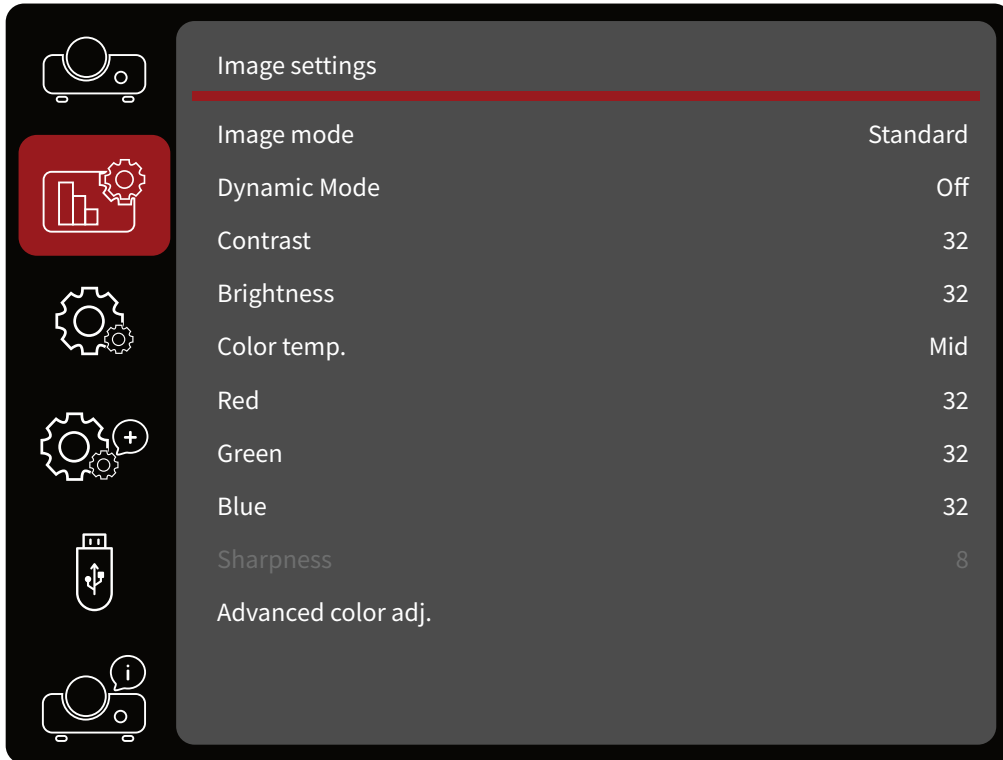

Menu	Description														
Image Mode	<p>There are several predefined display modes that you can choose from to suit your viewing preference.</p> <table border="1" style="width: 100%; border-collapse: collapse;"> <thead> <tr> <th style="background-color: #e91e63; color: white;">Mode</th> <th style="background-color: #e91e63; color: white;">Description</th> </tr> </thead> <tbody> <tr> <td style="text-align: center;">Standard</td> <td>Designed for normal circumstances in a daylight environment.</td> </tr> <tr> <td style="text-align: center;">Cinema</td> <td>Provides the best balance of detail and colors for watching movies.</td> </tr> <tr> <td style="text-align: center;">Golf</td> <td>Suitable for golf simulators.</td> </tr> <tr> <td style="text-align: center;">Colorboard</td> <td>Designed for environments with different wall colors.</td> </tr> <tr> <td style="text-align: center;">User</td> <td>User-specific, custom image settings.</td> </tr> <tr> <td style="text-align: center;">Brightest</td> <td>Suitable for bright, well-lit environments.</td> </tr> </tbody> </table>	Mode	Description	Standard	Designed for normal circumstances in a daylight environment.	Cinema	Provides the best balance of detail and colors for watching movies.	Golf	Suitable for golf simulators.	Colorboard	Designed for environments with different wall colors.	User	User-specific, custom image settings.	Brightest	Suitable for bright, well-lit environments.
Mode	Description														
Standard	Designed for normal circumstances in a daylight environment.														
Cinema	Provides the best balance of detail and colors for watching movies.														
Golf	Suitable for golf simulators.														
Colorboard	Designed for environments with different wall colors.														
User	User-specific, custom image settings.														
Brightest	Suitable for bright, well-lit environments.														
Dynamic Mode	<p><u>Off</u> Disable dynamic contrast.</p> <p><u>Mode 1/2/3</u> Adjust the light source level.</p>														
Contrast	Use this to set the peak white level after you have previously adjusted the Brightness setting to suit your selected input and viewing environment.														
Brightness	The higher the value, the brighter the image. Lower values will result in a darker image.														

Menu	Description
Color Temp.	<u>High/Mid/Low</u> Select from Warm, Standard, or Cold color temperatures. <u>User</u> Set a custom color temperature
Red	Adjusts the contrast levels of red.
Green	Adjusts the contrast levels of green.
Blue	Adjusts the contrast levels of blue.
Sharpness	A higher value will sharpen the image, while a lower value will soften the image.
Advanced Color Adj.	Only in permanent installations with controlled lighting levels such as boardrooms, lecture theaters should advanced color adjustment be considered. Advanced color adjustment provides fine color control adjustment to allow for more accurate color reproduction. Select the primary color first and adjust its range/values in hue, saturation, and gain.

Settings

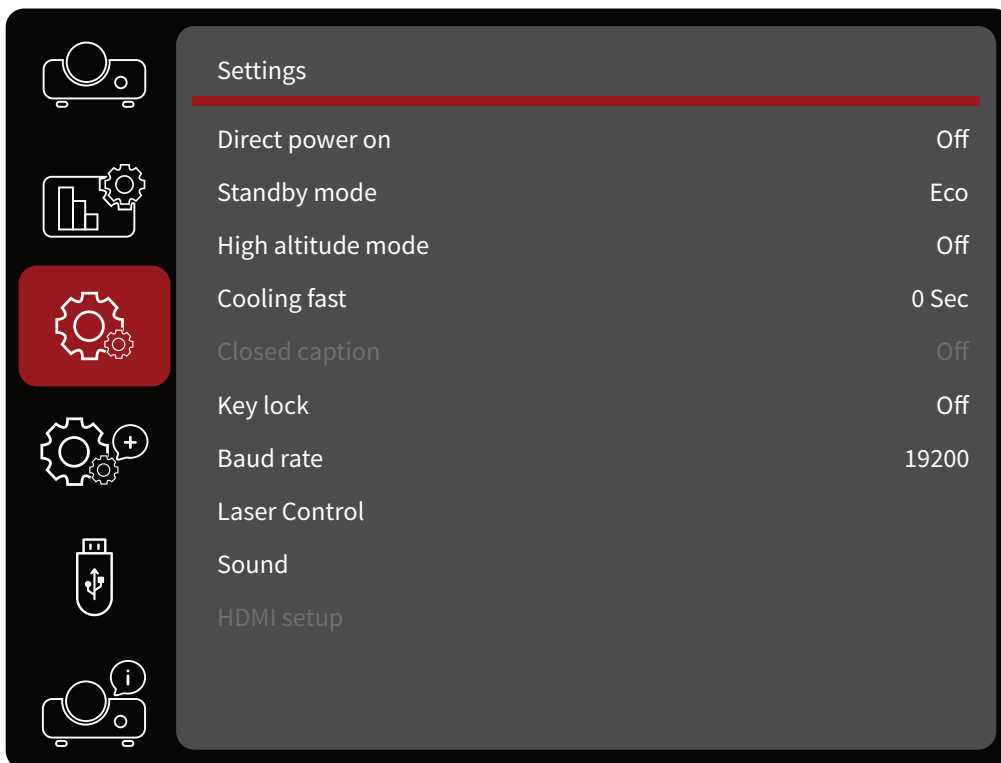

Menu	Description
Direct Power On	The projector will turn on automatically once connected to a power source.
Standby Mode	<p><u>Normal</u></p> <p>Normal standby > 0.5W; the Network setup function is available.</p> <p><u>Eco</u></p> <p>Eco standby < 0.5W; the Network setup function is not available.</p> <p><u>Network</u></p> <p>Network standby; only available Wake on LAN (WOL).</p>
High Altitude Mode	When turned on, the fans will spin faster for better cooling and performance. This is useful for high altitude environments where the air is thin. If set to Auto , the projector will activate the high-altitude mode automatically.
Cooling Fast	Select the cooling fan speed to shorten the cooling time.
Closed Caption²	Enables closed captioning when the selected input signal carries closed captions.
Key Lock	Lock and unlock the control panel.

² - Only available for **Video** input.

Menu	Description																		
Baud Rate	Set a baud rate that is identical with your computer's so that you can connect the projector using a suitable RS-232 cable and control the projector with RS-232 commands.																		
Laser Control	<p>Change the light source brightness according to the projector's operating environment.</p> <p><u>Normal</u> Adjustable brightness level, 50%~100%.</p> <p><u>Full</u> Non-adjustable brightness level, 100%.</p> <p><u>ECO1</u> 60% brightness level.</p> <p><u>ECO2</u> 50% brightness level.</p>																		
Sound	<p><u>Volume</u> Decrease or increase the sound level.</p> <p><u>Mute</u> Turn off or turn on the sound.</p>																		
HDMI Setup	<p><u>Image</u></p> <table border="1" style="width: 100%; border-collapse: collapse;"> <thead> <tr> <th style="background-color: #ff0000; color: white;">Mode</th> <th style="background-color: #ff0000; color: white;">Description</th> </tr> </thead> <tbody> <tr> <td style="text-align: center;">Auto</td> <td>Automatically set to standard signal.</td> </tr> <tr> <td style="text-align: center;">64~940</td> <td>Manually adjust the signal until the image is normal.</td> </tr> <tr> <td style="text-align: center;">0~1023</td> <td>Manually adjust the signal until the image is normal.</td> </tr> </tbody> </table> <p><u>Sound</u></p> <table border="1" style="width: 100%; border-collapse: collapse;"> <thead> <tr> <th style="background-color: #ff0000; color: white;">Mode</th> <th style="background-color: #ff0000; color: white;">Description</th> </tr> </thead> <tbody> <tr> <td style="text-align: center;">HDMI</td> <td>Output audio from the device connected to the HDMI port.</td> </tr> <tr> <td style="text-align: center;">Computer</td> <td>Output audio from the device connected to the COMPUTER port.</td> </tr> </tbody> </table> <p><u>HDMI EQ Settings</u></p> <table border="1" style="width: 100%; border-collapse: collapse;"> <thead> <tr> <th style="background-color: #ff0000; color: white;">Mode</th> <th style="background-color: #ff0000; color: white;">Description</th> </tr> </thead> <tbody> <tr> <td style="text-align: center;">0/1/2/3</td> <td>Adjust the HDMI input signal level according to the device connected to the HDMI port. If there is a lot of noise in the image, or problems such as the inability to project the image occur, the settings must be changed.</td> </tr> </tbody> </table>	Mode	Description	Auto	Automatically set to standard signal.	64~940	Manually adjust the signal until the image is normal.	0~1023	Manually adjust the signal until the image is normal.	Mode	Description	HDMI	Output audio from the device connected to the HDMI port.	Computer	Output audio from the device connected to the COMPUTER port.	Mode	Description	0/1/2/3	Adjust the HDMI input signal level according to the device connected to the HDMI port. If there is a lot of noise in the image, or problems such as the inability to project the image occur, the settings must be changed.
Mode	Description																		
Auto	Automatically set to standard signal.																		
64~940	Manually adjust the signal until the image is normal.																		
0~1023	Manually adjust the signal until the image is normal.																		
Mode	Description																		
HDMI	Output audio from the device connected to the HDMI port.																		
Computer	Output audio from the device connected to the COMPUTER port.																		
Mode	Description																		
0/1/2/3	Adjust the HDMI input signal level according to the device connected to the HDMI port. If there is a lot of noise in the image, or problems such as the inability to project the image occur, the settings must be changed.																		

Advanced

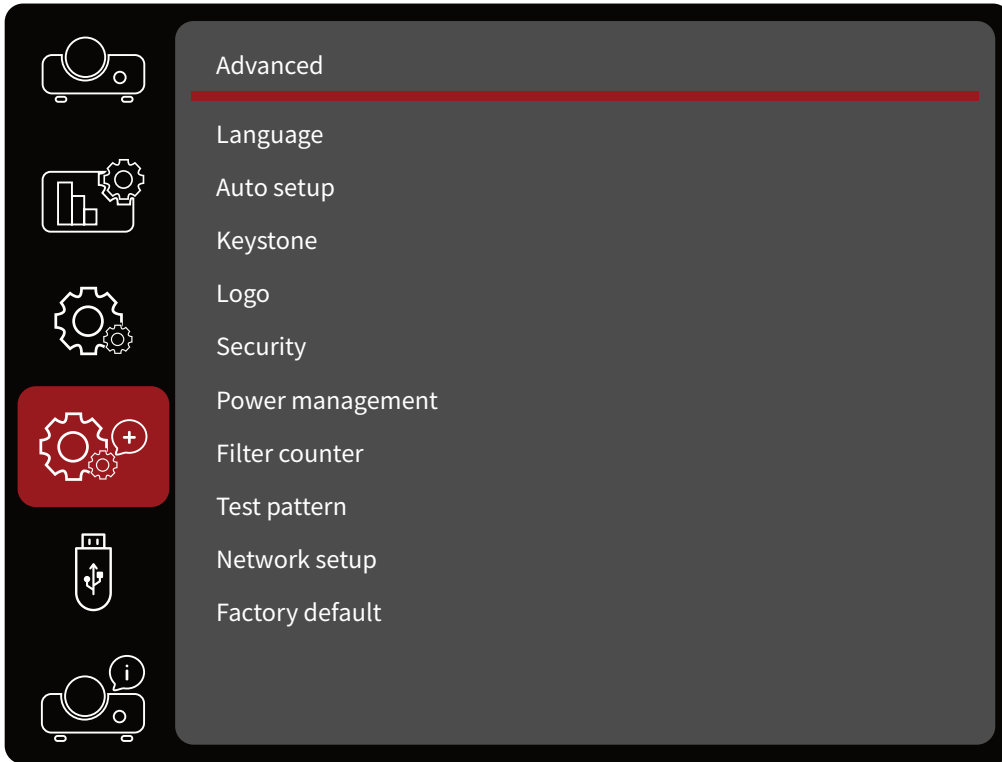

Menu	Description
Language	Select the On-Screen Display (OSD) Menu language.
Auto Setup	<p><u>Input Search</u> Automatically find and project an available input source.</p> <p><u>Auto PC Adj.</u> When Auto PC Adj. is turned on, the projector will input an analog signal. Pressing the Auto button on the remote control will adjust Fine Sync, H. Position, V. Position, and H. Size automatically. When Auto PC Adj. is turned off, the Auto button on the remote control will be unsupported.</p> <p><u>Auto Keystone</u> Automatically correct a distorted projected image.</p>

Menu	Description
<p>Keystone</p>	<p><u>Keystone</u> Store or reset the keystone correction after unplugging the power cord.</p> <p><u>H/V Keystone</u> Correct the projected image horizontally or vertically.</p> <p><u>4-Corner Correction</u> Correct the projected image's four corners.</p> <p><u>6-Corner Correction</u> Correct the projected images' six corners.</p> <p><u>Curved Correction</u> Correct a projected image that is uneven or deformed due to a curved surface.</p> <p><u>Grid Image Tune</u> Adjust the local points of the projected image.</p> <p><u>Reset</u> Return the settings to their default values.</p>
<p>Logo</p>	<p><u>Logo Select</u> Set the startup logo when powering on the projector.</p> <p><u>Capture</u> Capture images being projected and use it for a startup logo.</p> <p><u>Logo PIN Code Lock</u> Prevent unauthorized personnel from changing the logo screen.</p> <p><u>Logo PIN Code Change</u> Change the PIN code to any 3-digit number.</p>
<p>Security</p>	<p><u>PIN Code Lock</u> Prevent unauthorized personnel from operating the projector.</p> <p><u>PIN Code Change</u> Change the PIN code to any 3-digit number.</p>

Menu	Description
<p>Power Management</p>	<p><u>Ready</u></p> <p>A countdown will be displayed after 30 seconds without a signal input.</p> <p>Allows the projector to enable Ready mode automatically after a set period of time once no input source is detected .</p> <p>If the input signal is reconnected or any key (except the Power button) on the remote control or control panel is pressed, the light source will be turn back on.</p> <p><u>Shutdown</u></p> <p>A countdown will be displayed after 30 seconds without a signal input.</p> <p>Allows the projector to shut down automatically after a set period of time once no input source is detected to prevent unnecessary waste of light source life.</p> <p><u>Off</u></p> <p>Disable the power management function.</p> <p><u>Timer</u></p> <p>Sets period of time once no input source is detected and allows the projector to turn Ready mode automatically.</p> <p><u>Ready Countdown</u></p> <p>When Power Management is set to Ready, the transition time from Ready mode to standby mode is 0 to 30 minutes.</p> <p>If set to 0, the projector can not switch automatically. In Ready mode, press the Power button to switch the projector from Ready mode to Standby mode and press any other key to power on the projector.</p>

Menu	Description
<p>Filter Counter</p>	<p>The filter prevents dust from entering your projector, which can build up on internal parts. A blocked filter may reduce the cooling fan's efficiency, causing the projector to overheat and potentially shorten its lifespan. Clean the filter promptly whenever the Filter Warning icon appears.</p> <p>Please follow these steps to clean your filter:</p> <ol style="list-style-type: none"> 1. Turn off the projector and unplug it from its power source. 2. Remove the filter. 3. Gently clean it with a brush. 4. Replace the filter, making sure it has been inserted fully. <p><u>Filter Counter</u></p> <p>Display the filter's usage time.</p> <p><u>Timer</u></p> <p>Set the filter's cleaning time.</p> <p><u>Filter Counter Reset</u></p> <p>Reset the Filter Counter.</p> <p><u>Filter Status</u></p> <p>Check the filter time of the projector.</p>
<p>Test Pattern</p>	<p>Display the projector's built-in test pattern.</p> <p>NOTE: Not available for USB A, USB B, and LAN display.</p>
<p>Network Setup</p>	<p>Set the IP address, LAN, and DHCP settings.</p> <p>NOTE: The projector does not support wireless display. Users can purchase a Wi-Fi dongle with a built-in RTL8192EU driver.</p>
<p>Factory Default</p>	<p>Returns all settings to the factory preset values.</p> <p>NOTE: When using Reset Settings, the following settings will still remain: Language, Projector Projection, Baud Rate, High Altitude, and Light Source Hours.</p>

Controlling the Projector through a Network

The projector provides diverse networking and remote management features. The LAN /RJ45 function of the projector, through a network, can remotely manage: Power On/Off, Volume adjustment, Input select, Brightness, and more.

1. Connect the projector to a network via the LAN/RJ45 port.
2. Open the On-Screen Display Menu and go to: **Advanced > Network Setup**.
3. Select **DHCP** and turn it **On** to obtain an IP address automatically; or select **Off** to enter the network information manually.

NOTE: Please wait for around 15~20 seconds, then re-enter the **Network Setup** settings page. The Projector IP Address, Subnet Mask, Default Gateway, DNS Server settings will be displayed. Make note of the IP address displayed in the Projector IP Address row.

4. Using a web browser, and under the same network, type in the projector's IP address.
5. Enter the user name and password, then click **Log in**.

USB-A

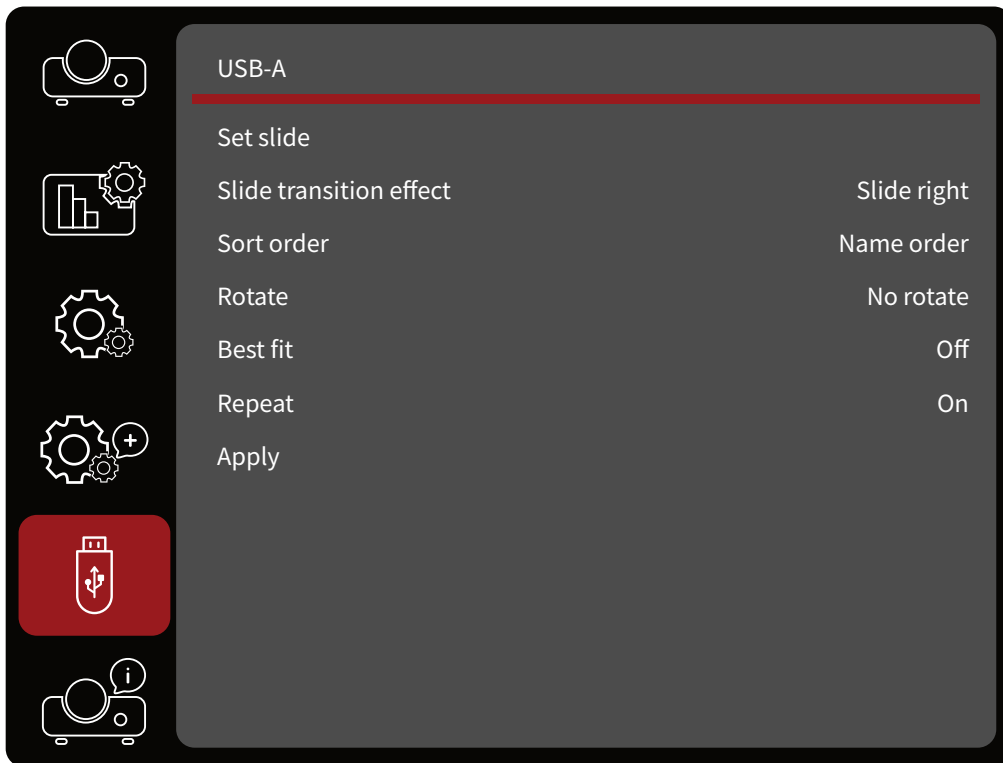

Menu	Description
Set Slide	Display slides.
Slide Transition Effect	Control slide playback transition effects.
Sort Order	Set the order of the slides.
Rotate	Set the rotation direction of images.
Best Fit	Set the image to fit with the projection screen.
Repeat	Play the slides repeatedly when turned on.
Apply	Enable the slide settings.

Supported File Formats

Video

Extension	Video Codec	Audio Codec	Video Format
.avi	MotionJPEG	ADPCM	1280 x 70, 30 FPS (Maximum)

Image

Extension	Format	Description
jpg/jpeg	Baseline encoder 24 Progressive RGB24 bit	Maximum Resolution: 10000 x 10000
		Maximum Resolution: Panel resolution
bmp	1.4.8 bit palette-based RGB24, 32-bit	Maximum Resolution: 1280 x 800
png	24, 48-bit True Color	-24-bit color palette space
		Maximum Resolution: 1024 x 768
gif	1, 4, 8-bit palette-based	Maximum Resolution: 800 x 600
tiff		Maximum Resolution: 800 x 600

Information

View Input source, H-Sync Freq., V-Sync Freq., Light Source Counter, MAC Address, Serial Number, Firmware Version, and SUBCPU information.

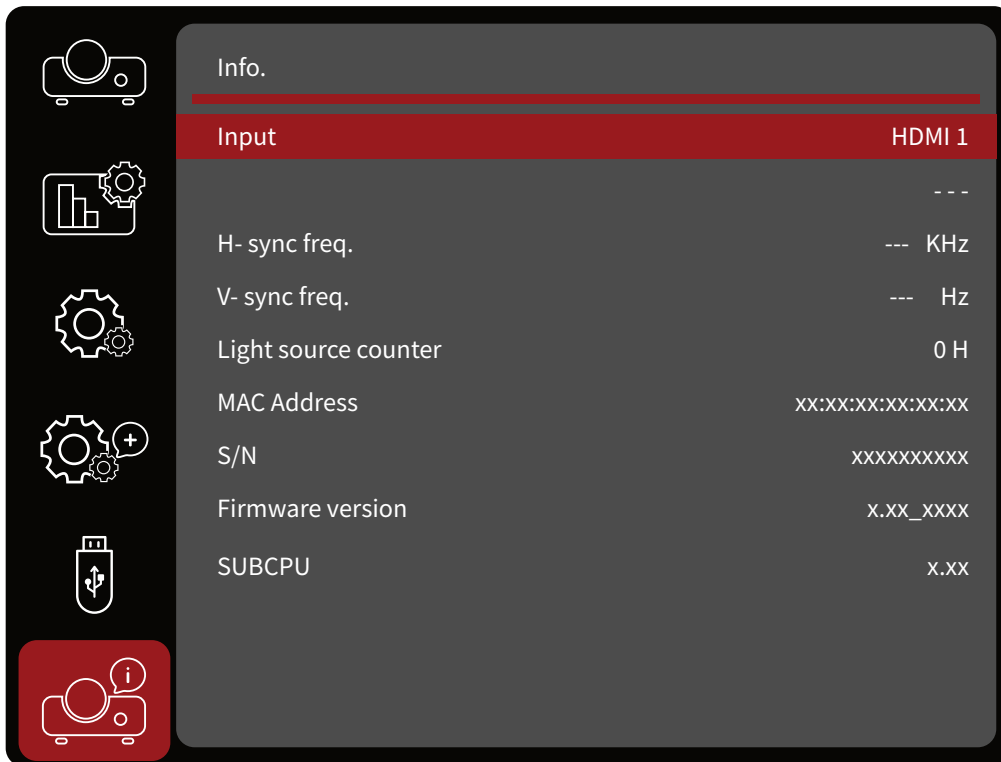

Appendix

Specifications

Item	Category	Specifications	
		LSC520WU	LSC521WU
Projector	Type	Laser	
	Display Size	30"~300"	
	Throw Ratio	1.08~1.76	1.2~2.01
	Lens	1.6x	
	Display System	3LCD	
Input Signal	HDMI	f_h : 15K~100 kHz, f_v : 24K~85 Hz, Pixel rate: 160 MHz	
	VGA	f_h : 15K~100 kHz, f_v : 24K~85 Hz, Pixel rate: 300 MHz	
Resolution	Native	1920 x 1200	
Power	Input Voltage	AC 100-240V, 50/60 Hz (auto switch)	
Operating Conditions	Altitude	1,700 to 3,000 m at 0°C to 40°C ¹	
		5,577.43 to 9,842.52 ft at 32°F to 104°F ¹	
	Relative Humidity	20% to 80% (non-condensing)	
	Temperature	0°C to 40°C 32°F to 104°F	
Storage Conditions	Relative Humidity	10% to 85% (non-condensing)	
	Temperature	-10°C to 50°C -14°F to 122°F	
Dimensions	Physical (W x H x D)	390 x 294 x 128 mm	
		15.35" x 11.57" x 5.04"	
Weight	Physical	5.2 kg	
		11.46 lb	
Power Consumption	On ²	236W (Typical)	
	Off	< 0.5W (Standby)	

1 - With High Altitude Mode enabled.

2 - The test condition follows EEI standards.

Projector Dimensions

390 mm (W) x 294 mm (H) x 128 mm (D)

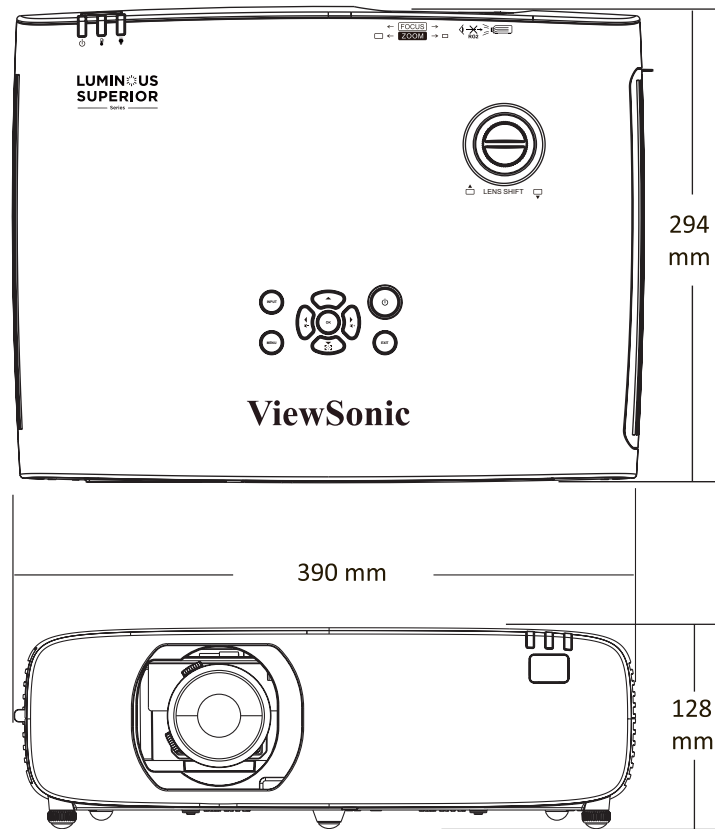

Timing Chart

PC Signal

Resolution	Refresh Rate
720 x 480i	60 Hz
720 x 576i	50 Hz
720 x 480p	60 Hz
720 x 576p	50 Hz
1280 x 720p	50, 60 Hz
1920 x 1080i	50, 60 Hz
1920 x 1080p	24, 50, 60 Hz
640 x 480	60, 67, 72, 75, 85 Hz
800 x 600	56, 60, 72, 75, 85 Hz
832 x 624	75 Hz
1024 x 768	60, 70, 75, 85 Hz
1152 x 864	70, 75 Hz
1280 x 720	60 Hz
1280 x 768	60, 75, 85 Hz
1280 x 800	60, 75, 85 Hz
1280 x 960	60 Hz
1280 x 1024	60, 72, 75, 85 Hz
1366 x 768	60 Hz
1400 x 1050	60, 75 Hz
1440 x 900	60 Hz
1600 x 900	60 Hz
1680 x 1050	60 Hz
1920 x 1080	60 Hz
1920 x 1200	60 Hz

HDMI Signal

HDMI Video

Resolution	Refresh Rate
720 x 480p	60 Hz
720 x 480i	60 Hz
720 x 576p	50 Hz
720 x 576i	60 Hz
1280 x 720p	50, 60 Hz
1920 x 1080i	50, 60 Hz
1920 x 1080p	24, 50, 60 Hz

HDMI PC

Resolution	Refresh Rate
640 x 480	60, 67, 72, 75, 85 Hz
800 x 600	56, 60, 72, 75, 85 Hz
832 x 624	75 Hz
1024 x 768	60, 70, 75, 85 Hz
1152 x 864	70, 75 Hz
1280 x 720	60 Hz
1280 x 768	60, 75, 85 Hz
1280 x 800	60, 75, 85 Hz
1280 x 960	60 Hz
1280 x 1024	60, 72, 75, 85 Hz
1366 x 768	60 Hz
1400 x 1050	60, 75 Hz
1440 x 900	60 Hz
1600 x 900	60 Hz
1680 x 1050	60 Hz
1920 x 1080	60 Hz
1920 x 1200	60 Hz
3840 x 2160	30 Hz

Troubleshooting

This section describes some common problems that you may experience when using the projector.

Problem or Issue	Possible Solutions
The projector does not turn on	<ul style="list-style-type: none">• Ensure the power cord is properly attached to the projector and to the power outlet.• If the cooling process has not completed, please wait until it has finished then try to turn on the projector again.• If the above does not work, try another power outlet or another electrical device with the same power outlet.
There is no picture	<ul style="list-style-type: none">• Ensure the video source cable is connected properly, and that the video source is turned on.• If the input source is not selected automatically, select the correct source with the “Source Input” on either the projector or the remote control.
The image is blurred	<ul style="list-style-type: none">• Adjusting focus with the Focus Ring will help correctly focus the projection lens.• Ensure the projector and screen are aligned properly. If necessary, adjust the height of the projector as well as the projection angle and direction.
The image is reversed	<ul style="list-style-type: none">• Open the OSD Menu and go to: Setup > Projection and adjust the projection option.
The image is stretched when projecting a 16:9 DVD	<ul style="list-style-type: none">• When you play an anamorphic DVD or 16:9 DVD, the projector will show the best image in 16:9.• If you play a 4:3 format DVD title, please change the format as 4:3 in projector OSD Menu.• Please setup the display format as 16:9 (wide) aspect ratio on the DVD player.

Problem or Issue	Possible Solutions
The remote control does not work	<ul style="list-style-type: none"> • Ensure there are no obstacles between the remote control and projector; and that they are within range, 8 m (26 ft). • The batteries may be out of power, please check and replace if necessary.
The projector stops responding to all controls	<ul style="list-style-type: none"> • Turn off the projector and unplug the power cord. Wait at least 20 seconds then reconnect and try again.

LED Indicators

When the warning indicators (see below) light up or flash, the projector will automatically shutdown. Unplug the power cord from the projector, wait for 30 seconds and try again. If the warning indicators light up or flash, please contact your nearest service center for assistance.

Status and Description	Power Indicator Light	Status Indicator Light	Light Source Indicator Light
Normal Standby (> 0.5W)	Steady Orange	Off	Off
Network/Eco Standby (< 0.5W)	Flashing Orange	Off	Off
Power On (Warming)	Flashing Orange	Off	Off
Power Off (Cooling)	Flashing Red	Off	Off
Light Source Error	Steady Red	Steady Red	Steady Red
Fan Error	Steady Red	Flashing Orange	Off
Temperature Error	Steady Red	Flashing Red	Off
Filter Error	Steady Green	Flashing Red	Off

Maintenance

General Precautions

- Make sure the projector is turned off and the power cable is unplugged from the power outlet.
- Never remove any parts from the projector. Contact ViewSonic® or a reseller when any part of the projector needs replacing.
- Never spray or pour any liquid directly onto the case.
- Handle the projector with care, as a darker-colored projector, if scuffed, may show marks more clearly than a lighter-colored projector.

Cleaning the Lens

- Use a canister of compressed air to remove dust.
- If the lens is still not clean, use lens-cleaning paper or moisten a soft cloth with lens cleaner and gently wipe the surface.

CAUTION: Never rub the lens with abrasive materials.

Cleaning the Case

- Use a soft, lint-free, dry cloth to remove dirt or dust.
- If the case is still not clean, apply a small amount of non-ammonia, non-alcohol based, mild non-abrasive detergent onto a clean, soft, lint-free cloth, then wipe the surface.

CAUTION: Never use wax, alcohol, benzene, thinner, or other chemical detergents.

Storing the Projector

If you intend to store the projector for an extended period of time:

- Ensure the temperature and humidity of the storage area are within the recommend range.
- Retract the adjuster foot completely.
- Remove the batteries from the remote control.
- Pack the projector in its original packaging or equivalent.

Disclaimer

- ViewSonic® does not recommend the use of any ammonia or alcohol-based cleaners on the lens or case. Some chemical cleaners have been reported to damage the lens and/or case of the projector.
- ViewSonic® will not be liable for damage resulting from use of any ammonia or alcohol-based cleaners.

Cleaning the Filter

Please follow these steps to clean your filter:

1. Turn off the projector and unplug it from its power source.
2. Remove the filter.
3. Gently clean it with a brush.
4. Replace the filter, making sure it has been inserted fully.

CAUTION: Do not operate the projector after removing the filter. Otherwise, dust will adhere to the lens assembly, compromising image quality.

Regulatory and Service Information

Compliance Information

This section addresses all connected requirements and statements regarding regulations. Confirmed corresponding applications shall refer to nameplate labels and relevant markings on the unit.

FCC Compliance Statement

This device complies with part 15 of FCC Rules. Operation is subject to the following two conditions: (1) this device may not cause harmful interference, and (2) this device must accept any interference received, including interference that may cause undesired operation. This equipment has been tested and found to comply with the limits for a Class B digital device, pursuant to part 15 of the FCC Rules.

These limits are designed to provide reasonable protection against harmful interference in a residential installation. This equipment generates, uses, and can radiate radio frequency energy, and if not installed and used in accordance with the instructions, may cause harmful interference to radio communications. However, there is no guarantee that interference will not occur in a particular installation. If this equipment does cause harmful interference to radio or television reception, which can be determined by turning the equipment off and on, the user is encouraged to try to correct the interference by one or more of the following measures:

- Reorient or relocate the receiving antenna.
- Increase the separation between the equipment and receiver.
- Connect the equipment into an outlet on a circuit different from that to which the receiver is connected.
- Consult the dealer or an experienced radio/TV technician for help.

Warning: You are cautioned that changes or modifications not expressly approved by the party responsible for compliance could void your authority to operate the equipment.

Industry Canada Statement

CAN ICES (B) / NMB (B)

This Class B digital apparatus complies with Canadian ICES-003.

Cet appareil numérique de classe B est conforme à la norme NMB-003 du Canada.

CE Conformity for European Countries

CE The device complies with the EMC Directive 2014/30/EU and Low Voltage Directive 2014/35/EU. Ecodesign Directive 2009/125/EC.

The following information is only for EU-member states:

The mark shown to the right is in compliance with the Waste Electrical and Electronic Equipment Directive 2012/19/EU (WEEE). The mark indicates the requirement NOT to dispose of the equipment as unsorted municipal waste, but use the return and collection systems according to local law.



Declaration of RoHS2 Compliance

This product has been designed and manufactured in compliance with Directive 2011/65/EU of the European Parliament and the Council on restriction of the use of certain hazardous substances in electrical and electronic equipment (RoHS2 Directive) and is deemed to comply with the maximum concentration values issued by the European Technical Adaptation Committee (TAC) as shown below:

Substance	Proposed Maximum Concentration	Actual Concentration
Lead (Pb)	0.1%	< 0.1%
Mercury (Hg)	0.1%	< 0.1%
Cadmium (Cd)	0.01%	< 0.01%
Hexavalent Chromium (Cr6 ⁺)	0.1%	< 0.1%
Polybrominated biphenyls (PBB)	0.1%	< 0.1%
Polybrominated diphenyl ethers (PBDE)	0.1%	< 0.1%
Bis (2-ethylhexyl) phthalate (DEHP)	0.1%	< 0.1%
Butyl benzyl phthalate (BBP)	0.1%	< 0.1%
Dibutyl phthalate (DBP)	0.1%	< 0.1%
Diisobutyl phthalate (DIBP)	0.1%	< 0.1%

Certain components of products as stated above are exempted under the Annex III of the RoHS2 Directives as noted below. Examples of exempted components are:

- Mercury in cold cathode fluorescent lamps and external electrode fluorescent lamps (CCFL and EEFL) for special purposes not exceeding (per lamp):
 - » Short length (500 mm): maximum 3.5 mg per lamp.
 - » Medium length (> 500 mm and 1,500 mm): maximum 5 mg per lamp.
 - » Long length (> 1,500 mm): maximum 13 mg per lamp.
- Lead in glass of cathode ray tubes.
- Lead in glass of fluorescent tubes not exceeding 0.2% by weight.
- Lead as an alloying element in aluminum containing up to 0.4% lead by weight.
- Copper alloy containing up to 4% lead by weight.
- Lead in high melting temperature type solders (i.e. lead-based alloys containing 85% by weight or more lead).
- Electrical and electronic components containing lead in a glass or ceramic other than dielectric ceramic in capacitors, e.g. piezoelectronic devices, or in a glass or ceramic matrix compound.

Indian Restriction of Hazardous Substances

Restriction on Hazardous Substances statement (India). This product complies with the “India E-waste Rule 2011” and prohibits use of lead, mercury, hexavalent chromium, polybrominated biphenyls or polybrominated diphenyl ethers in concentrations exceeding 0.1 weight % and 0.01 weight % for cadmium, except for the exemptions set in Schedule 2 of the Rule.

Product Disposal at End of Product Life

ViewSonic® respects the environment and is committed to working and living green. Thank you for being part of Smarter, Greener Computing. Please visit the ViewSonic® website to learn more.

USA & Canada:

<https://www.viewsonic.com/us/go-green-with-viewsonic>

Europe:

<https://www.viewsonic.com/eu/environmental-social-governance/recycle>

Taiwan:

<https://recycle.moenv.gov.tw/>

For EU users, please contact us for any safety/accident issue experienced with this product:

ViewSonic Europe Limited



Haaksbergweg 75
1101 BR Amsterdam
Netherlands



+31 (0) 650608655



EPREL@viewsoniceurope.com



<https://www.viewsonic.com/eu/>

Copyright Information

Copyright© ViewSonic® Corporation, 2024. All rights reserved.

Macintosh and Power Macintosh are registered trademarks of Apple Inc.

Microsoft, Windows, and the Windows logo are registered trademarks of Microsoft Corporation in the United States and other countries.

ViewSonic® and the three birds logo are registered trademarks of ViewSonic® Corporation.

VESA is a registered trademark of the Video Electronics Standards Association. DPMS, DisplayPort, and DDC are trademarks of VESA.

ENERGY STAR® is a registered trademark of the U.S. Environmental Protection Agency (EPA).

As an ENERGY STAR® partner, ViewSonic® Corporation has determined that this product meets the ENERGY STAR® guidelines for energy efficiency.

Disclaimer: ViewSonic® Corporation shall not be liable for technical or editorial errors or omissions contained herein; nor for incidental or consequential damages resulting from furnishing this material, or the performance or use of this product.

In the interest of continuing product improvement, ViewSonic® Corporation reserves the right to change product specifications without notice. Information in this document may change without notice.

No part of this document may be copied, reproduced, or transmitted by any means, for any purpose without prior written permission from ViewSonic® Corporation.

Customer Service

For technical support or product service, see the table below or contact your reseller.

NOTE: You will need the product's serial number.

Country/ Region	Website	Country/ Region	Website
Asia Pacific & Africa			
Australia	www.viewsonic.com/au/	Bangladesh	www.viewsonic.com/bd/
中国 (China)	www.viewsonic.com.cn	香港 (繁體中文)	www.viewsonic.com/hk/
Hong Kong (English)	www.viewsonic.com/hk-en/	India	www.viewsonic.com/in/
Indonesia	www.viewsonic.com/id/	Israel	www.viewsonic.com/il/
日本 (Japan)	www.viewsonic.com/jp/	Korea	www.viewsonic.com/kr/
Malaysia	www.viewsonic.com/my/	Middle East	www.viewsonic.com/me/
Myanmar	www.viewsonic.com/mm/	Nepal	www.viewsonic.com/np/
New Zealand	www.viewsonic.com/nz/	Pakistan	www.viewsonic.com/pk/
Philippines	www.viewsonic.com/ph/	Singapore	www.viewsonic.com/sg/
臺灣 (Taiwan)	www.viewsonic.com/tw/	ประเทศไทย	www.viewsonic.com/th/
Việt Nam	www.viewsonic.com/vn/	South Africa & Mauritius	www.viewsonic.com/za/
Americas			
United States	www.viewsonic.com/us	Canada	www.viewsonic.com/us
Latin America	www.viewsonic.com/la		
Europe			
Europe	www.viewsonic.com/eu/	France	www.viewsonic.com/fr/
Deutschland	www.viewsonic.com/de/	Қазақстан	www.viewsonic.com/kz/
Россия	www.viewsonic.com/ru/	España	www.viewsonic.com/es/
Türkiye	www.viewsonic.com/tr/	Україна	www.viewsonic.com/ua/
United Kingdom	www.viewsonic.com/uk/		

Limited Warranty

ViewSonic® Projector

What the warranty covers:

ViewSonic® warrants its products to be free from defects in material and workmanship, under normal use, during the warranty period. If a product proves to be defective in material or workmanship during the warranty period, ViewSonic® will, at its sole option, repair or replace the product with a like product. Replacement product or parts may include remanufactured or refurbished parts or components.

Limited Three (3) year General Warranty:

Subject to the more limited one (1) year warranty set out below, North and South America: Three (3) years warranty for all parts excluding the lamp, three (3) years for labor, and one (1) year for the original lamp from the date of the first consumer purchase.

Other regions or countries: Please check with your local dealer or local ViewSonic® office for the warranty information.

Limited One (1) year Heavy Usage Warranty:

Under heavy usage settings, where a projector's use includes more than fourteen (14) hours average daily usage, North and South America: One (1) year warranty for all parts excluding the lamp, one (1) year for labor, and ninety (90) days for the original lamp from the date of the first consumer purchase; Europe: One (1) year warranty for all parts excluding the lamp, one (1) year for labor, and ninety (90) days for the original lamp from the date of the first consumer purchase. Other regions or countries: Please check with your local dealer or local ViewSonic® office for the warranty information. Lamp warranty subject to terms and conditions, verification and approval. Applies to manufacturer's installed lamp only. All accessory lamps purchased separately are warranted for 90 days.

Who the warranty protects:

This warranty is valid only for the first consumer purchaser.

What the warranty does not cover:

1. Any product on which the serial number has been defaced, modified, or removed.
2. Damage, deterioration, or malfunction resulting from:
 - » Accident, misuse, neglect, fire, water, lightning, or other acts of nature, unauthorized product modification, or failure to follow instructions supplied with the product.
 - » Operation outside of product specifications.
 - » Operation of the product for other than the normal intended use or not under normal conditions.
 - » Repair or attempted repair by anyone not authorized by ViewSonic®.
 - » Any damage of the product due to shipment.
 - » Removal or installation of the product.
 - » Causes external to the product, such as electric power fluctuations or failure.
 - » Use of supplies or parts not meeting Viewsonic's specifications.
 - » Normal wear and tear.
 - » Any other cause which does not relate to a product defect.
3. Removal, installation, and set-up service charges.

How to get service:

1. For information about receiving service under warranty, contact ViewSonic® Customer Support (Please refer to the "Customer Support" page). You will need to provide your product's serial number.
2. To obtain warranted service, you will be required to provide: (a) the original dated sales slip, (b) your name, (c) your address, (d) a description of the problem, and (e) the serial number of the product.
3. Take or ship the product, freight prepaid, in the original container to an authorized ViewSonic® service center or ViewSonic®.
4. For additional information or the name of the nearest ViewSonic® service center, contact ViewSonic®.

Limitation of implied warranties:

There are no warranties, express or implied, which extend beyond the description contained herein including the implied warranty of merchantability and fitness for a particular purpose.

Exclusion of damages:

ViewSonic's liability is limited to the cost of repair or replacement of the product. ViewSonic® shall not be liable for:

1. Damage to other property caused by any defects in the product, damages based upon inconvenience, loss of use of the product, loss of time, loss of profits, loss of business opportunity, loss of goodwill, interference with business relationships, or other commercial loss, even if advised of the possibility of such damages.
2. Any other damages, whether incidental, consequential or otherwise.
3. Any claim against the customer by any other party.

Effect of state law:

This warranty gives you specific legal rights, and you may also have other rights which vary from local authority. Some local governments do not allow limitations on implied warranties and/or do not allow the exclusion of incidental or consequential damages, so the above limitations and exclusions may not apply to you.

Sales outside the U.S.A. and Canada:

For warranty information and service on ViewSonic® products sold outside of the U.S.A. and Canada, contact ViewSonic® or your local ViewSonic® dealer.

The warranty period for this product in mainland China (Hong Kong, Macao, and Taiwan Excluded) is subject to the terms and conditions of the Maintenance Guarantee Card.

For users in Europe and Russia, full details of warranty provided can be found at: <http://www.viewsonic.com/eu/> under "Support/Warranty Information".

Mexico Limited Warranty

ViewSonic® Projector

What the warranty covers:

ViewSonic® warrants its products to be free from defects in material and workmanship, under normal use, during the warranty period. If a product proves to be defective in material or workmanship during the warranty period, ViewSonic® will, at its sole option, repair or replace the product with a like product. Replacement product or parts may include remanufactured or refurbished parts or components & accessories.

How long the warranty is effective:

3 years for all parts excluding the lamp, 3 years for labor, 1 year for the original lamp from the date of the first consumer purchase.

Lamp warranty subject to terms and conditions, verification and approval. Applies to manufacturer's installed lamp only.

All accessory lamps purchased separately are warranted for 90 days.

Who the warranty protects:

This warranty is valid only for the first consumer purchaser.

What the warranty excludes and does not cover:

1. Any product on which the serial number has been defaced, modified or removed.
2. Damage, deterioration, or malfunction resulting from:
 - » Accident, misuse, neglect, fire, water, lightning, or other acts of nature, unauthorized product modification, unauthorized attempted repair, or failure to follow instructions supplied with the product.
 - » Any damage of the product due to shipment.
 - » Causes external to the product, such as electrical power fluctuations or failure.
 - » Use of supplies or parts not meeting ViewSonic®'s specifications.
 - » Normal wear and tear.
 - » Any other cause which does not relate to a product defect.
3. Any product exhibiting a condition commonly known as "image burn-in" which results when a static image is displayed on the product for an extended period of time.
4. Removal, installation, insurance, and set-up service charges.

How to get service:

For information about receiving service under warranty, contact ViewSonic® Customer Support (Please refer to the attached “Customer Service” page). You will need to provide your product’s serial number, so please record the product information in the space provided below on your purchase for your future use. Please retain your receipt of proof of purchase to support your warranty claim.

For Your Records

Product Name: _____ Model Number: _____

Document Number: _____ Serial Number: _____

Purchase Date: _____ Extended Warranty Purchase? _____ (Y/N)

If so, what date does warranty expire? _____

1. To obtain warranty service, you will be required to provide (a) the original dated sales slip, (b) your name, (c) your address, (d) a description of the problem, and (e) the serial number of the product.
2. Take or ship the product, in the original container packaging, to an authorized ViewSonic® service center.
3. Round trip transportation costs for in-warranty products will be paid by ViewSonic®.

Limitation of implied warranties:

There are no warranties, express or implied, which extend beyond the description contained herein including the implied warranty of merchantability and fitness for a particular purpose.

Exclusion of damages:

ViewSonic®’s liability is limited to the cost of repair or replacement of the product. ViewSonic® shall not be liable for:

1. Damage to other property caused by any defects in the product, damages based upon inconvenience, loss of use of the product, loss of time, loss of profits, loss of business opportunity, loss of goodwill, interference with business relationships, or other commercial loss, even if advised of the possibility of such damages.
2. Any other damages, whether incidental, consequential or otherwise.
3. Any claim against the customer by any other party.
4. Repair or attempted repair by anyone not authorized by ViewSonic®.

Contact Information for Sales & Authorized Service (Centro Autorizado de Servicio) within Mexico:	
<p align="center">Name, address, of manufacturer and importers: México, Av. de la Palma #8 Piso 2 Despacho 203, Corporativo Interpalmas, Col. San Fernando Huixquilucan, Estado de México Tel: (55) 3605-1099 http://www.viewsonic.com/la/soporte/index.htm</p>	
NÚMERO GRATIS DE ASISTENCIA TÉCNICA PARA TODO MÉXICO: 001.866.823.2004	
<p>Hermosillo: Distribuciones y Servicios Computacionales SA de CV. Calle Juarez 284 local 2 Col. Bugambilias C.P: 83140 Tel: 01-66-22-14-9005 E-Mail: disc2@hmo.megared.net.mx</p>	<p>Villahermosa: Compumantenimientos Garantizados, S.A. de C.V. AV. GREGORIO MENDEZ #1504 COL, FLORIDA C.P. 86040 Tel: 01 (993) 3 52 00 47 / 3522074 / 3 52 20 09 E-Mail: compumantenimientos@prodigy.net.mx</p>
<p>Puebla, Pue. (Matriz): RENTA Y DATOS, S.A. DE C.V. Domicilio: 29 SUR 721 COL. LA PAZ 72160 PUEBLA, PUE. Tel: 01(52).222.891.55.77 CON 10 LINEAS E-Mail: datos@puebla.megared.net.mx</p>	<p>Veracruz, Ver.: CONEXION Y DESARROLLO, S.A DE C.V. Av. Americas # 419 ENTRE PINZÓN Y ALVARADO Fracc. Reforma C.P. 91919 Tel: 01-22-91-00-31-67 E-Mail: gacosta@qplus.com.mx</p>
<p>Chihuahua: Soluciones Globales en Computación C. Magisterio # 3321 Col. Magisterial Chihuahua, Chih. Tel: 4136954 E-Mail: Cefeo@soluglobales.com</p>	<p>Cuernavaca: Compusupport de Cuernavaca SA de CV Francisco Leyva # 178 Col. Miguel Hidalgo C.P. 62040, Cuernavaca Morelos Tel: 01 777 3180579 / 01 777 3124014 E-Mail: aquevedo@compusupportcva.com</p>
<p>Distrito Federal: QPLUS, S.A. de C.V. Av. Coyoacán 931 Col. Del Valle 03100, México, D.F. Tel: 01(52)55-50-00-27-35 E-Mail : gacosta@qplus.com.mx</p>	<p>Guadalajara, Jal.: SERVICRECE, S.A. de C.V. Av. Niños Héroes # 2281 Col. Arcos Sur, Sector Juárez 44170, Guadalajara, Jalisco Tel: 01(52)33-36-15-15-43 E-Mail: mmiranda@servicrece.com</p>
<p>Guerrero Acapulco: GS Computación (Grupo Sesiscomp) Progreso #6-A, Colo Centro 39300 Acapulco, Guerrero Tel: 744-48-32627</p>	<p>Monterrey: Global Product Services Mar Caribe # 1987, Esquina con Golfo Pérsico Fracc. Bernardo Reyes, CP 64280 Monterrey N.L. México Tel: 8129-5103 E-Mail: aydeem@gps1.com.mx</p>
<p>MÉRIDA: ELECTROSER Av Reforma No. 403Gx39 y 41 Mérida, Yucatán, México CP97000 Tel: (52) 999-925-1916 E-Mail: rrrb@sureste.com</p>	<p>Oaxaca, Oax.: CENTRO DE DISTRIBUCION Y SERVICIO, S.A. de C.V. Murguía # 708 P.A., Col. Centro, 68000, Oaxaca Tel: 01(52)95-15-15-22-22 Fax: 01(52)95-15-13-67-00 E-Mail: gpotai2001@hotmail.com</p>
<p>Tijuana: STD Av Ferrocarril Sonora #3780 L-C Col 20 de Noviembr Tijuana, Mexico</p>	<p>FOR USA SUPPORT: ViewSonic® Corporation 381 Brea Canyon Road, Walnut, CA. 91789 USA Tel: 800-688-6688 E-Mail: http://www.viewsonic.com</p>

