

**VPC-A31-O1**  
**VS19699**  
 Slot in PC module

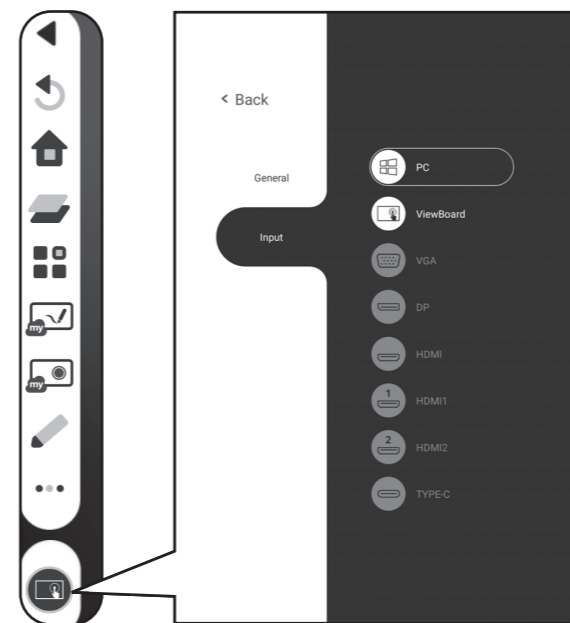

IFP Series

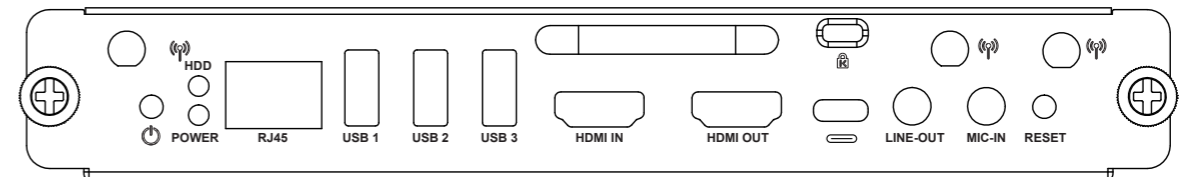
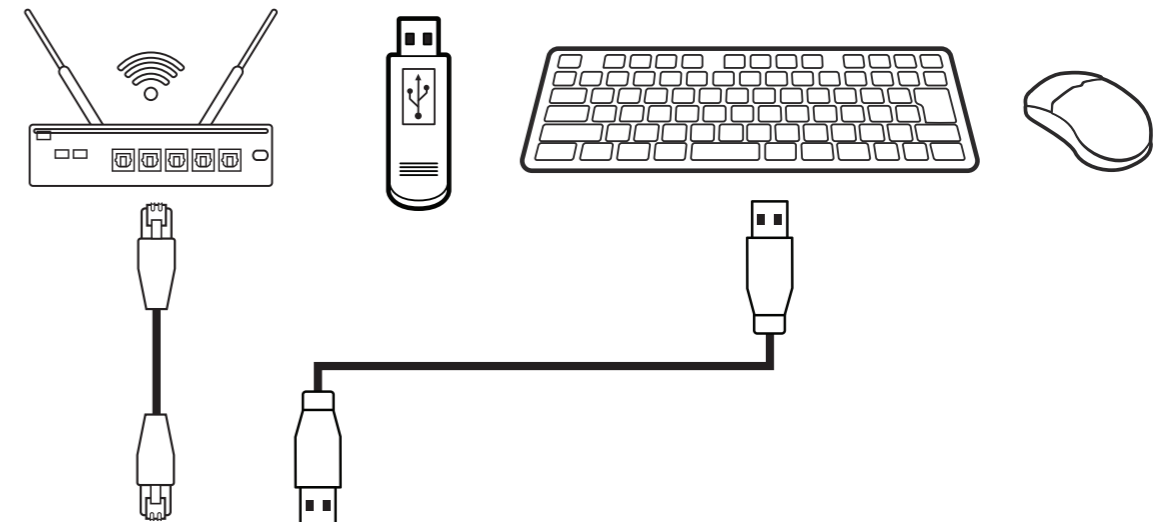
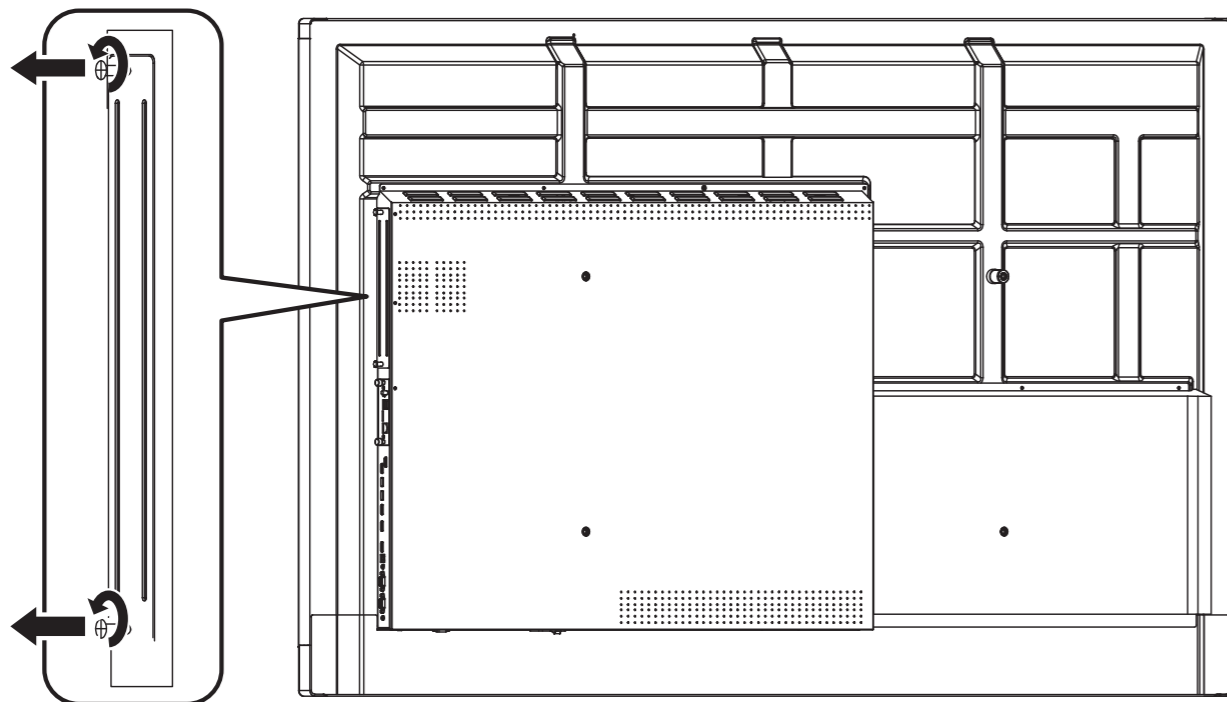
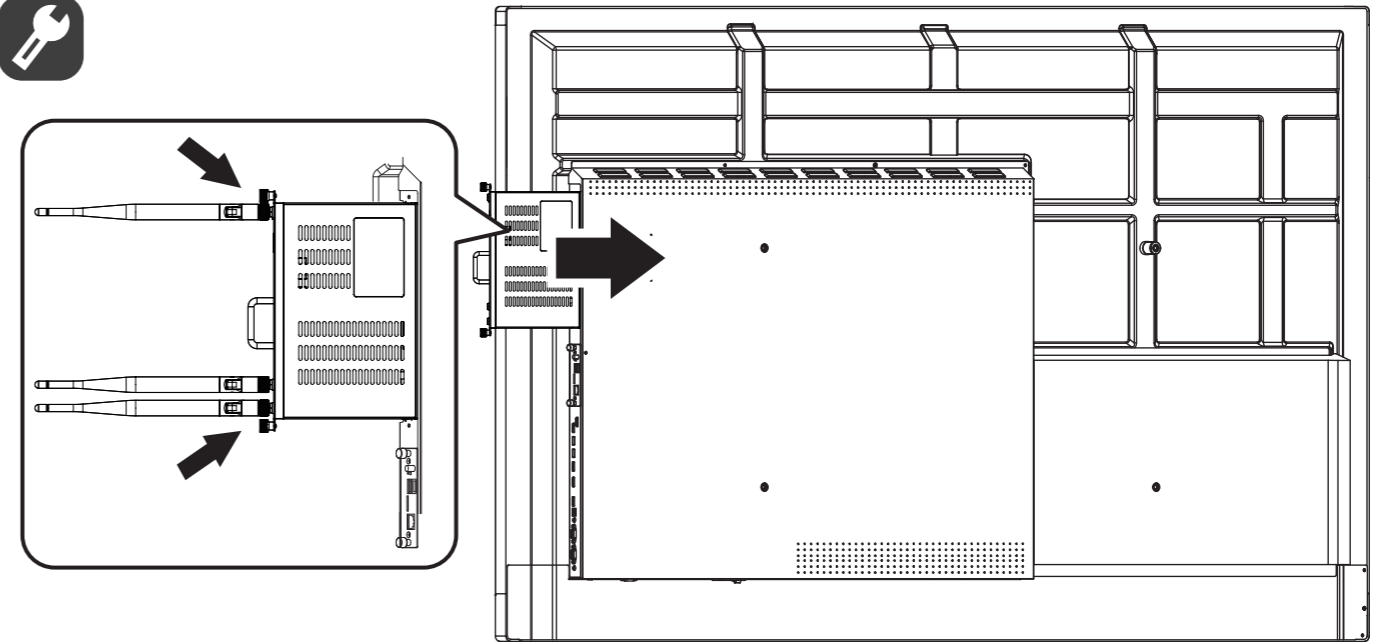
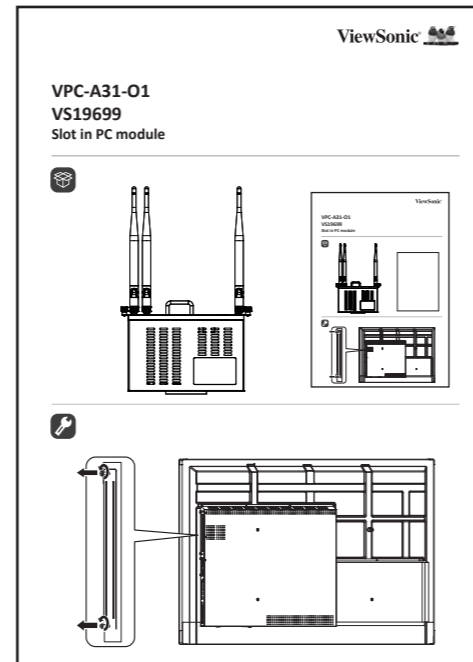
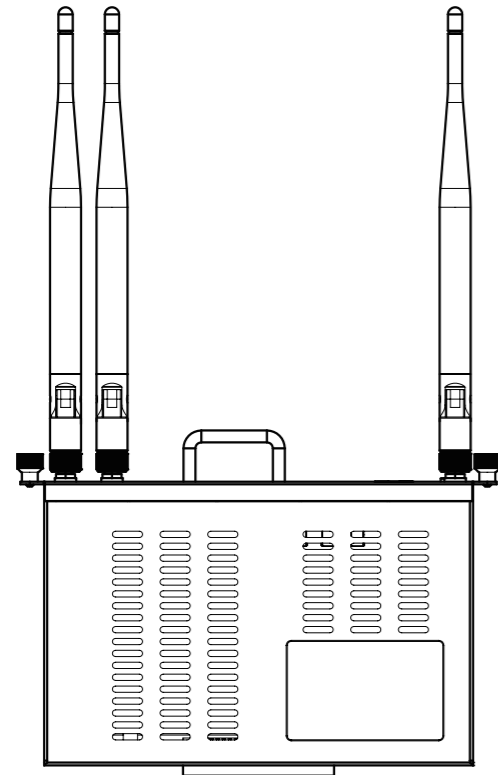
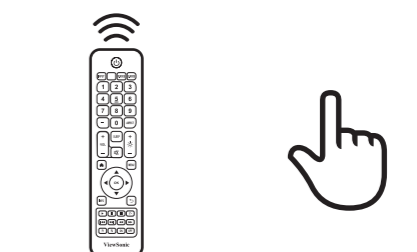
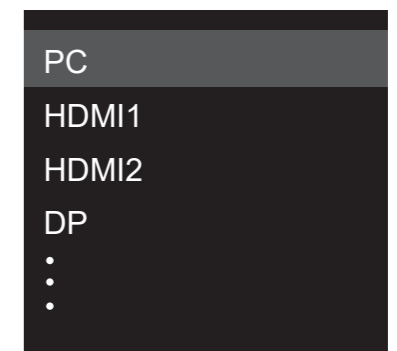

CDE Series IFPG1 Series



#### FCC Compliance Statement

This device complies with part 15 of FCC Rules. Operation is subject to the following two conditions: (1) this device may not cause harmful interference, and (2) this device must accept any interference received, including interference that may cause undesired operation.

#### Industry Canada Statement

CAN ICES-003(B) / NMB-003(B)

#### CE Conformity for European Countries

The device complies with the EMC Directive 2014/30/EU and Low Voltage Directive 2014/35/EU and Radio Equipment Directive (RED) 2014/53/EU.

[https://www.viewsonicglobal.com/public/products\\_download/safety\\_compliance/acc/VS19699\\_CE\\_DOC.pdf](https://www.viewsonicglobal.com/public/products_download/safety_compliance/acc/VS19699_CE_DOC.pdf)

#### FCC-Hinweise

Dieses Gerät erfüllt alle Anforderungen des Teils 15 der FCC-Bestimmungen. Der Betrieb muss die folgenden zwei Bedingungen erfüllen: (1) Das Gerät darf keine schädlichen Interferenzen verursachen, und (2) das Gerät muss alle empfangenen Interferenzen inklusive der Interferenzen, die eventuell einen unerwünschten Betrieb verursachen, annehmen.

#### Industry Canada-Hinweis

CAN ICES-003(B) / NMB-003(B)

#### CE-Konformität für europäische Länder

Das Gerät erfüllt die Anforderungen der EMV-Richtlinie 2014/30/EU und der Niederspannungsrichtlinie 2014/35/EU und Funkgeräte-Richtlinie 2014/53/EU.

[https://www.viewsonicglobal.com/public/products\\_download/safety\\_compliance/acc/VS19699\\_CE\\_DOC.pdf](https://www.viewsonicglobal.com/public/products_download/safety_compliance/acc/VS19699_CE_DOC.pdf)

#### Overensstemmelseerklæring fra FCC

Denne enhed overholder stk. 15 i FCC-reglerne. Driften er underlagt følgende to betingelser: (1) Denne enhed må ikke forårsage skadelig interferens, og (2) denne enhed skal acceptere enhver modtaget interferens, herunder interferens, der kan forårsage uønsket drift.

#### Erklæring fra Industry Canada

CAN ICES-003(B) / NMB-003(B)

#### CE-overensstemmelse for europæiske lande

Enheden er i overensstemmelse med EMC-direktivet 2014/30/EU og lavspændingsdirektivet 2014/35/EU og direktivet om radioustyret (RED) 2014/53/EU.

[https://www.viewsonicglobal.com/public/products\\_download/safety\\_compliance/acc/VS19699\\_CE\\_DOC.pdf](https://www.viewsonicglobal.com/public/products_download/safety_compliance/acc/VS19699_CE_DOC.pdf)

#### FCC-nalevingsverklaring

Dit apparaat voldoet aan Deel 15 van de FCC-voorschriften. Gebruik is onderworpen aan de volgende twee voorwaarden: (1) dit apparaat mag geen schadelijke ruis veroorzaken en (2) dit apparaat dient ontvangen ruis te accepteren, inclusief ruis die ongewenste werking kan veroorzaken.

#### Verklaring voor Canadese bedrijven

CAN ICES-003(B) / NMB-003(B)

#### CE-verklaring van conformiteit voor Europese landen

Het apparaat voldoet aan de EMC-richtlijn 2014/30/EU en Laagspanningsrichtlijn 2014/35/EU en Richtlijn betreffende radio-apparatuur (RED) 2014/53/EU.

[https://www.viewsonicglobal.com/public/products\\_download/safety\\_compliance/acc/VS19699\\_CE\\_DOC.pdf](https://www.viewsonicglobal.com/public/products_download/safety_compliance/acc/VS19699_CE_DOC.pdf)

#### Declaración de conformidad de la FCC (Comisión Federal de Comunicaciones)

Este dispositivo cumple con el Apartado 15 de las normas FCC. El funcionamiento está sujeto a las dos condiciones siguientes: (1) Este dispositivo no debe causar interferencias perjudiciales, y (2) Este dispositivo debe aceptar cualquier interferencia recibida, incluidas aquellas que provoquen un funcionamiento no deseado.

#### Declaración del Departamento de Industria de Canadá

CAN ICES-003(B) / NMB-003(B)

#### Certificación CE para países europeos

Este dispositivo cumple con la Directiva EMC (Compatibilidad Electromagnética) 2014/30/EU y la Directiva de Baja Tensión 2014/35/EU y Directiva para equipos de radio 2014/53/UE.

[https://www.viewsonicglobal.com/public/products\\_download/safety\\_compliance/acc/VS19699\\_CE\\_DOC.pdf](https://www.viewsonicglobal.com/public/products_download/safety_compliance/acc/VS19699_CE_DOC.pdf)

#### FCC-yhdenmukaisuusilmoitus

Laitte on FCC-sääntöjen osan 15 mukainen. Laitteen käyttöä koskevat seuraavat kaksi ehtoa: (1) tämä laite saattaa aiheuttaa haitallista häiriötä, ja (2) tämän laitteen tulee vastaanottaa siihen tuleva häiriö, mukaan lukien häiriöt, joka voivat aiheuttaa ei-toivottuja toimintoja.

#### Industry Canada -ilmoitus

CAN ICES-003(B) / NMB-003(B)

#### CE-yhdenmukaisuus Euroopan maissa

Tämä laite on EMC-direktiivin 2014/30/EU ja matalajännittdirektiivin 2014/35/EU ja radiolaittdirektiivin (RED) 2014/53/EU vaatimusten mukainen.

[https://www.viewsonicglobal.com/public/products\\_download/safety\\_compliance/acc/VS19699\\_CE\\_DOC.pdf](https://www.viewsonicglobal.com/public/products_download/safety_compliance/acc/VS19699_CE_DOC.pdf)

#### Declaration de conformite FCC

Cet appareil est conforme à l'article 15 des Règlements FCC. Son fonctionnement est sujet aux deux conditions suivantes: (1) Cet appareil ne doit pas provoquer d'interférences néfastes, et (2) cet appareil doit accepter toutes les interférences reçues, y compris celles pouvant provoquer un fonctionnement indésirable.

#### Declaration de l'Industrie canadienn

CAN ICES-003(B) / NMB-003(B)

#### Conformité CE pour les pays européens

L'appareil est conforme la norme EMC 2014/30/EU et à la norme sur la basse tension 2014/35/EU et directive Équipements radioélectriques 2014/53/UE.

[https://www.viewsonicglobal.com/public/products\\_download/safety\\_compliance/acc/VS19699\\_CE\\_DOC.pdf](https://www.viewsonicglobal.com/public/products_download/safety_compliance/acc/VS19699_CE_DOC.pdf)

#### Δήλωση συμμόρφωσης με την FCC

Η παρούσα συσκευή συμμορφώνεται με το Μέρος 15 των κανόνων της Επιτροπής FCC. Η λειτουργία υπόκειται στους εξής δύο όρους: (1) αυτή η συσκευή δεν μπορεί να προκαλέσει επιβλαβή παρεμβολή, και (2) αυτή η συσκευή πρέπει να αποδέχεται οποιαδήποτε παρεμβολή, συμπεριλαμβανομένης παρεμβολής που μπορεί να προκαλέσει ανεπιθύμητη λειτουργία.

#### Δήλωση Industry Canada

CAN ICES-003(B) / NMB-003(B)

#### Συμμόρφωση CE για τις Ευρωπαϊκές χώρες

Η συσκευή συμμορφώνεται με την Οδηγία EMC 2014/30/ΕΕ, την Οδηγία περί χαμηλής τάσης 2014/35/ΕΕ και την Οδηγία για τον ραδιοεξοπλισμό (RED) 2014/53/ΕΕ.

[https://www.viewsonicglobal.com/public/products\\_download/safety\\_compliance/acc/VS19699\\_CE\\_DOC.pdf](https://www.viewsonicglobal.com/public/products_download/safety_compliance/acc/VS19699_CE_DOC.pdf)

#### FCC-samsvarserklæring

Denne enheten samsvarer med del 15 i FCC-reglene. Bruk er underlagt følgende to betingelser: (1) Denne enheten skal ikke forårsake skadelig interferens, og (2) denne enheten må godta all mottatt interferens, inkludert interferens som kan forårsake uønsket drift.

#### Industry Canada-erklæring

CAN ICES-003(B) / NMB-003(B)

#### CE-samsvar for europeiske land

Enheten samsvarer med EMC-direktivet 2014/30/EU, Lavspenningsdirektivet 2014/35/EU og Radioustyrsdirektivet (RED) 2014/53/EU.

[https://www.viewsonicglobal.com/public/products\\_download/safety\\_compliance/acc/VS19699\\_CE\\_DOC.pdf](https://www.viewsonicglobal.com/public/products_download/safety_compliance/acc/VS19699_CE_DOC.pdf)

#### Declaração de conformidade da FCC

Este dispositivo está em conformidade com o Artigo 15º das Normas da FCC. O seu funcionamento está sujeito às duas condições seguintes: (1) este dispositivo não poderá causar interferências prejudiciais, e (2) este dispositivo deve aceitar quaisquer interferências recebidas, incluindo interferências que possam causar um funcionamento indesejado.

#### Declaração do Departamento de indústria do Canadá

CAN ICES-003(B) / NMB-003(B)

#### Conformidade CE para países europeus

O dispositivo cumpre a Diretiva CEM 2014/30/UE e a Diretiva de Baixa Tensão 2014/35/UE e a Diretiva de Equipamentos de Rádio (RED) 2014/53/UE.

[https://www.viewsonicglobal.com/public/products\\_download/safety\\_compliance/acc/VS19699\\_CE\\_DOC.pdf](https://www.viewsonicglobal.com/public/products_download/safety_compliance/acc/VS19699_CE_DOC.pdf)

#### Соответствие требованиям Федеральной комиссии по связи США (FCC)

Данное устройство соответствует требованиям Части 15 Правил FCC. Работа должна соответствовать следующим двум условиям: (1) данные устройства не могут являться источниками вредных помех, и (2) данные устройства должны работать в условиях помех, включая те, которые могут вызывать сбои в работе.

#### Соответствие требованиям Министерства промышленности Канады

CAN ICES-003(B) / NMB-003(B)

#### Соответствие стандартам ЕС для европейских стран

Данное устройство соответствует требованиям Директивы 2014/30/ЕС на электромагнитную совместимость и Директиве 2014/35/ЕС на низковольтное оборудование и Директива о радиоборудовании 2014/53/ЕУ.

[https://www.viewsonicglobal.com/public/products\\_download/safety\\_compliance/acc/VS19699\\_CE\\_DOC.pdf](https://www.viewsonicglobal.com/public/products_download/safety_compliance/acc/VS19699_CE_DOC.pdf)

#### Uttalande gällande FCC-efterlevnad

Denna enhet överensstämmer med avsnitt 15 i FCC-reglerna. Användningen är underställd följande två villkor: (1) Enheten får inte orsaka skadliga störningar och (2) Denna enhet måste acceptera alla mottagna störningar, inklusive störningar som kan orsaka oönskad funktion.

#### Uttalande från Industry Canada

CAN ICES-003(B) / NMB-003(B)

#### CE-överensstämmelse för europeiska länder

Enheten överensstämmer med EMC-direktivet 2014/30/EU, lågspänningsdirektivet 2014/35/EU och direktivet om radioutrustning (RED) 2014/53/EU.

[https://www.viewsonicglobal.com/public/products\\_download/safety\\_compliance/acc/VS19699\\_CE\\_DOC.pdf](https://www.viewsonicglobal.com/public/products_download/safety_compliance/acc/VS19699_CE_DOC.pdf)

#### FCC Uyumluluk Bildirimi

Bu aygıt, FCC Kuralları kısım 15'e uygundur. Kullanım aşağıdaki iki koşula bağlıdır: (1) Bu aygıt zararlı girişime neden olamaz ve (2) bu aygıt istenmeyen çalışmaya neden olabilen girişim dahil olmak üzere alınan her türlü girişimi kabul etmelidir.

#### Industry Canada Bildirimi

CAN ICES-003(B) / NMB-003(B)

#### Avrupa Ülkeleri İçin CE Uyumluluğu

Aygıt, EMC Yönergesi 2014/30/EU ve Düşük Voltaj Yönergesi 2014/35/EU'ya uygundur ve Radyo Ekipman Direktifi 2014/53/AB.

[https://www.viewsonicglobal.com/public/products\\_download/safety\\_compliance/acc/VS19699\\_CE\\_DOC.pdf](https://www.viewsonicglobal.com/public/products_download/safety_compliance/acc/VS19699_CE_DOC.pdf)

#### FCC 符合性聲明

本設備符合 FCC 規則第 15 部分的規定。操作時有以下兩種情況：(1) 本裝置不會造成有害的干擾，以及 (2) 本裝置必須接受任何接收到的干擾，包括造成操作不良的干擾。

#### 加拿大工業部聲明

CAN ICES-003(B) / NMB-003(B)

#### CE 歐洲國家聲明

本裝置符合 EMC 指令 2014/30/EU、低電壓指令 2014/35/EU 及無線電設備指令(RED) 2014/53/EU。

[https://www.viewsonicglobal.com/public/products\\_download/safety\\_compliance/acc/VS19699\\_CE\\_DOC.pdf](https://www.viewsonicglobal.com/public/products_download/safety_compliance/acc/VS19699_CE_DOC.pdf)

#### 台灣RoHS符合性聲明

台灣RoHS/限用物質含有情況標示資訊請參考下列網址：

[https://www.viewsonicglobal.com/public/products\\_download/safety\\_compliance/acc/VS19699\\_BSMI\\_RoHS.pdf](https://www.viewsonicglobal.com/public/products_download/safety_compliance/acc/VS19699_BSMI_RoHS.pdf)

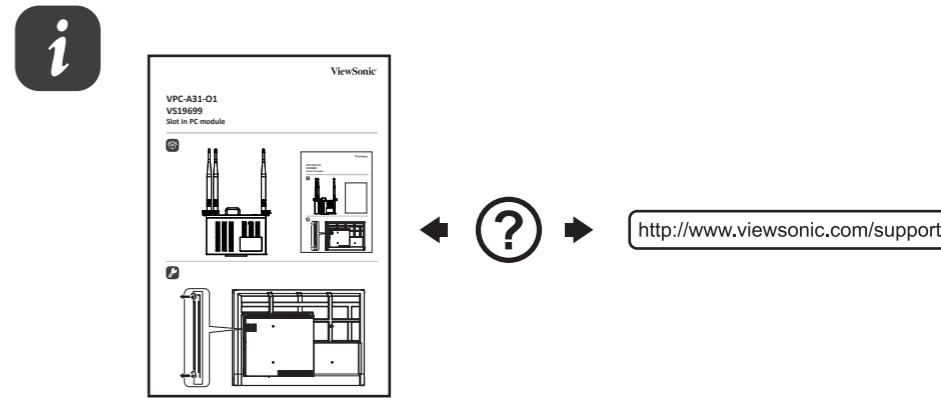

VPC-A31-01



Support Center



www.viewsonic.com



#### ViewSonic Europe Limited

Haaksbergweg 75  
1101 BR Amsterdam  
Netherlands



EPREL@viewsoniceurope.com



+31 (0) 650608655



<https://www.viewsonic.com/eu/>

VPC-A31-01\_QSG\_1b\_20240321  
Copyright © 2024 ViewSonic Corporation. All rights reserved.